

# Proper Orbifold Cohomotopy for M-Theory

Urs Schreiber on joint work with Hisham Sati

NYU AD Science Division, Program of Mathematics

& Center for Quantum and Topological Systems

New York University, Abu Dhabi

talk at:

String and M-Theory

The New Geometry of the 21<sup>st</sup> Century

II

via NUS Singapore, Nov.-Dec. 2021

While perturbative string theory is  $\sim$  well-defined (via worldsheet SCFT), defining non-perturbative brane physics (M-theory) has remained an open problem.

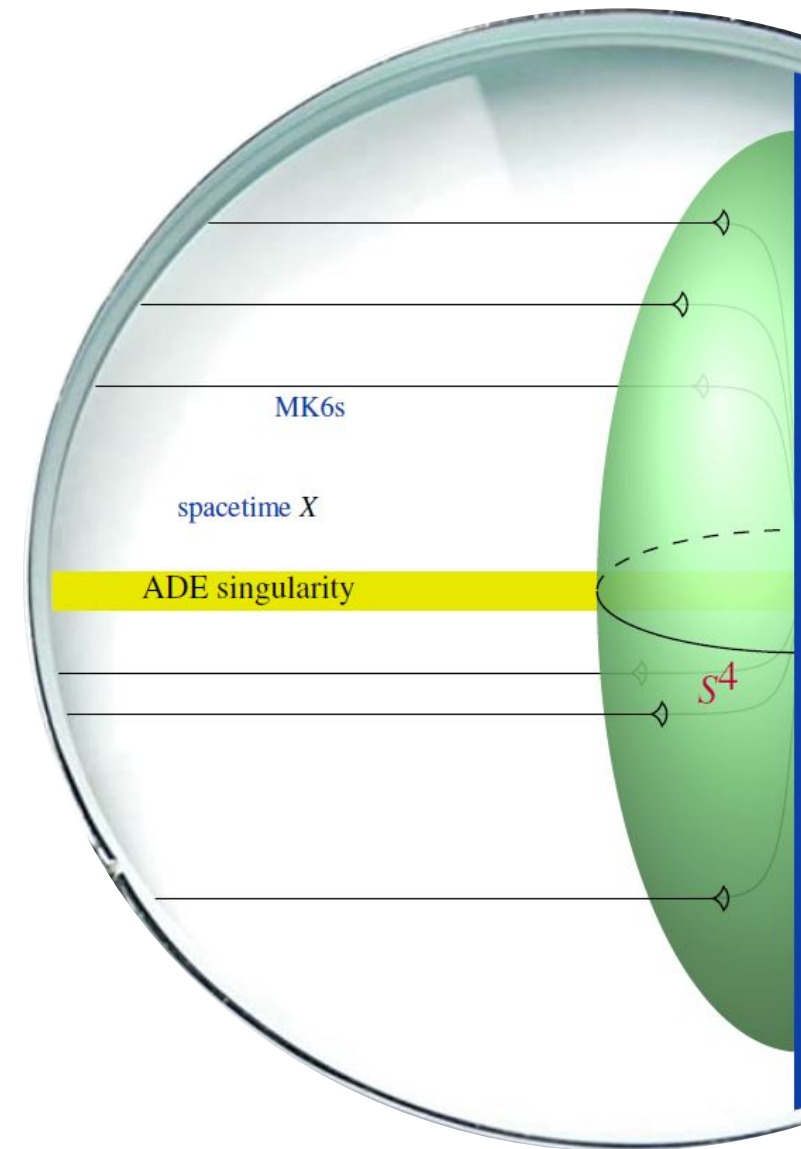

While perturbative string theory is  $\sim$  well-defined (via worldsheet SCFT), defining non-perturbative brane physics (M-theory) has remained an open problem.

Hypothesis H is a new proposal for the mathematical definition of the quantum states/charges of M-theory

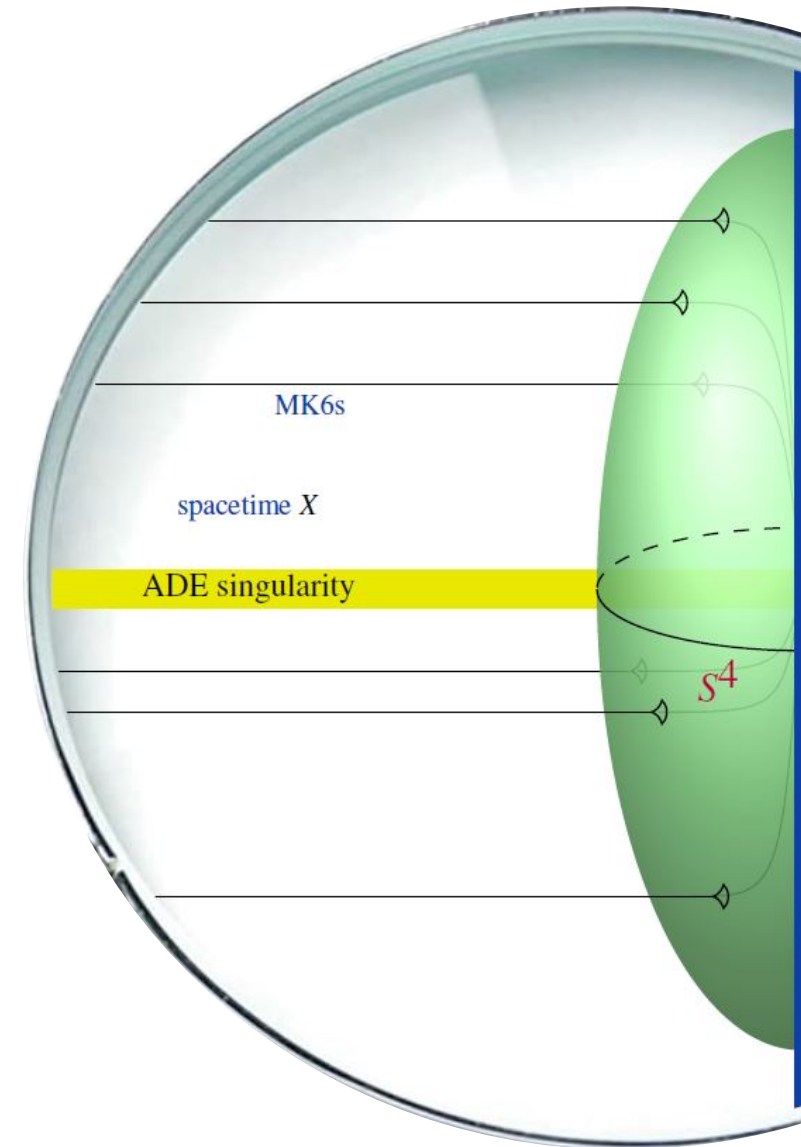

While perturbative string theory is  $\sim$  well-defined (via worldsheet SCFT), defining non-perturbative brane physics (M-theory) has remained an open problem.

**Hypothesis H** is a new proposal for the mathematical definition of the quantum states/charges of M-theory

in the vein of two previous proposals for string theory:

- a) derived categories with Bridgeland-stability,
- b) twisted topological K-theory.

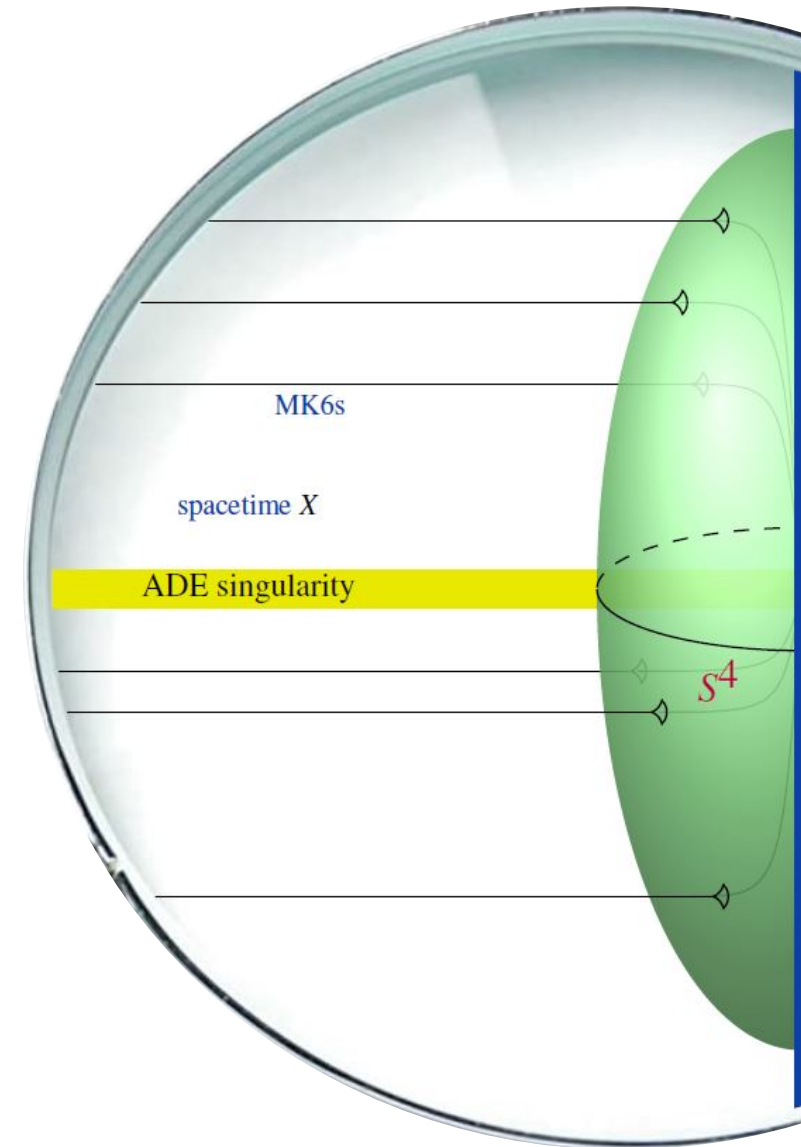

While perturbative string theory is  $\sim$  well-defined (via worldsheet SCFT), defining non-perturbative brane physics (M-theory) has remained an open problem.

**Hypothesis H** is a new proposal for the mathematical definition of the quantum states/charges of M-theory

in the vein of two previous proposals for string theory:

- a) derived categories with Bridgeland-stability,
- b) twisted topological K-theory.

**Hypothesis H** combines:

- the higher homotopy category theory of (a)
  - the generalized cohomology theory of (b)
- but made (a) *non-linear* and (b) *non-abelian*.

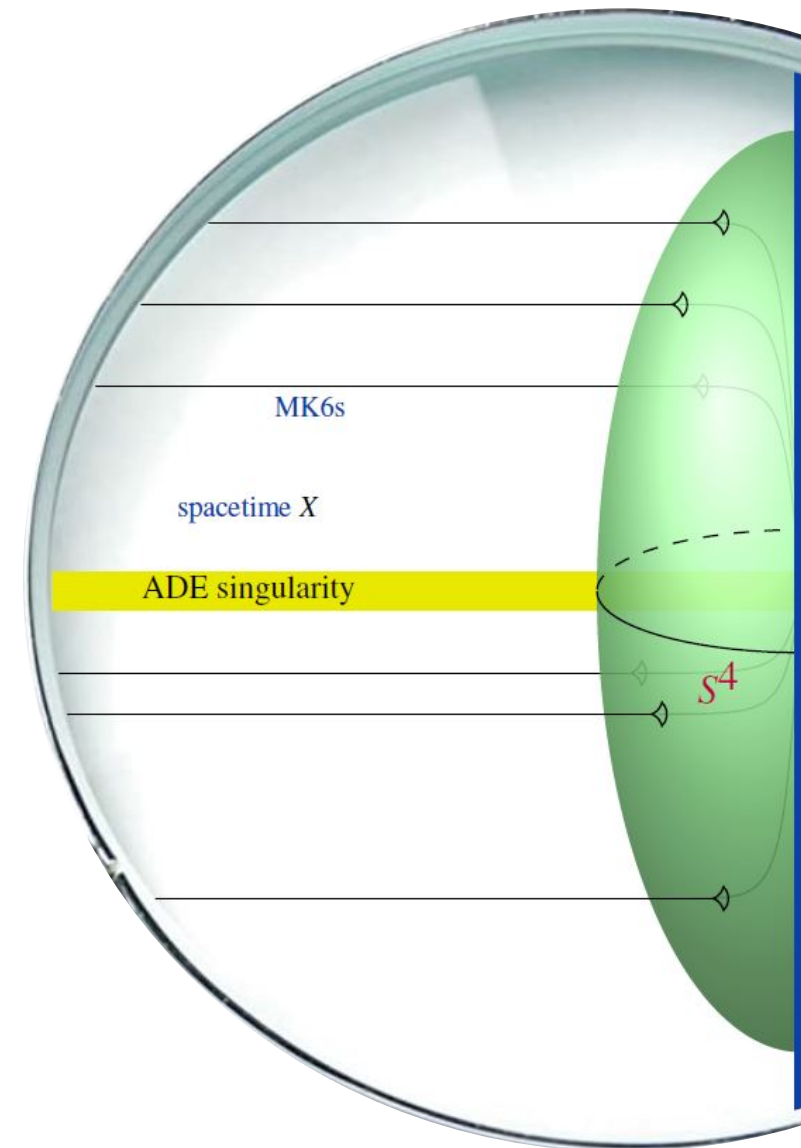

While perturbative string theory is  $\sim$  well-defined (via worldsheet SCFT), defining non-perturbative brane physics (M-theory) has remained an open problem.

**Hypothesis H** is a new proposal for the mathematical definition of the quantum states/charges of M-theory

in the vein of two previous proposals for string theory:

- a) derived categories with Bridgeland-stability,
- b) twisted topological K-theory.

**Hypothesis H** combines:

- the higher homotopy category theory of (a)
  - the generalized cohomology theory of (b)
- but made (a) *non-linear* and (b) *non-abelian*.

**Hypothesis H** asserts, in short, that:

*M-brane charge is quantized in*

*J-twisted 4-Cohomotopy theory.*

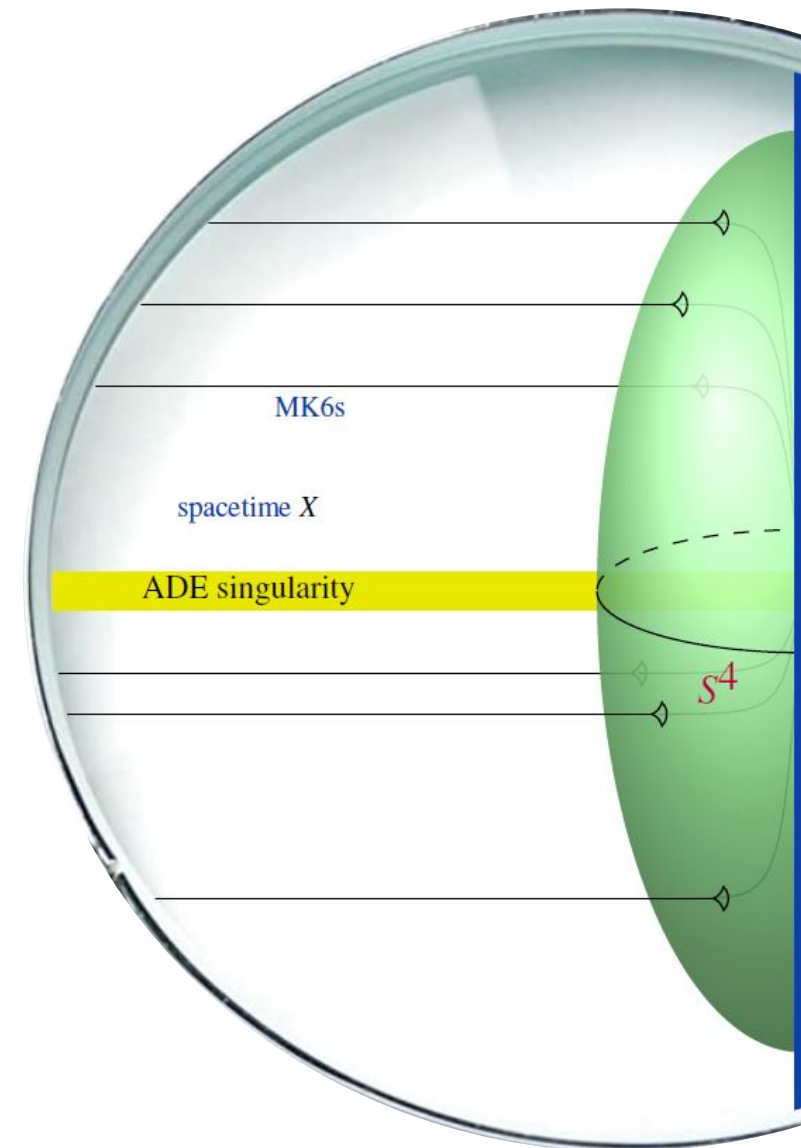

While perturbative string theory is  $\sim$  well-defined (via worldsheet SCFT), defining non-perturbative brane physics (M-theory) has remained an open problem.

**Hypothesis H** is a new proposal for the mathematical definition of the quantum states/charges of M-theory

in the vein of two previous proposals for string theory:

- a) derived categories with Bridgeland-stability,
- b) twisted topological K-theory.

**Hypothesis H** combines:

- the higher homotopy category theory of (a)
  - the generalized cohomology theory of (b)
- but made (a) *non-linear* and (b) *non-abelian*.

**Hypothesis H** asserts, in short, that:

*M-brane charge is quantized in*

*J-twisted 4-Cohomotopy theory*.

**This talk surveys what this means** and how this

- 1) is made precise over orbi-super-spacetimes;
- 2) implies conjectured fractional M5 tadpole cancellation (& more).

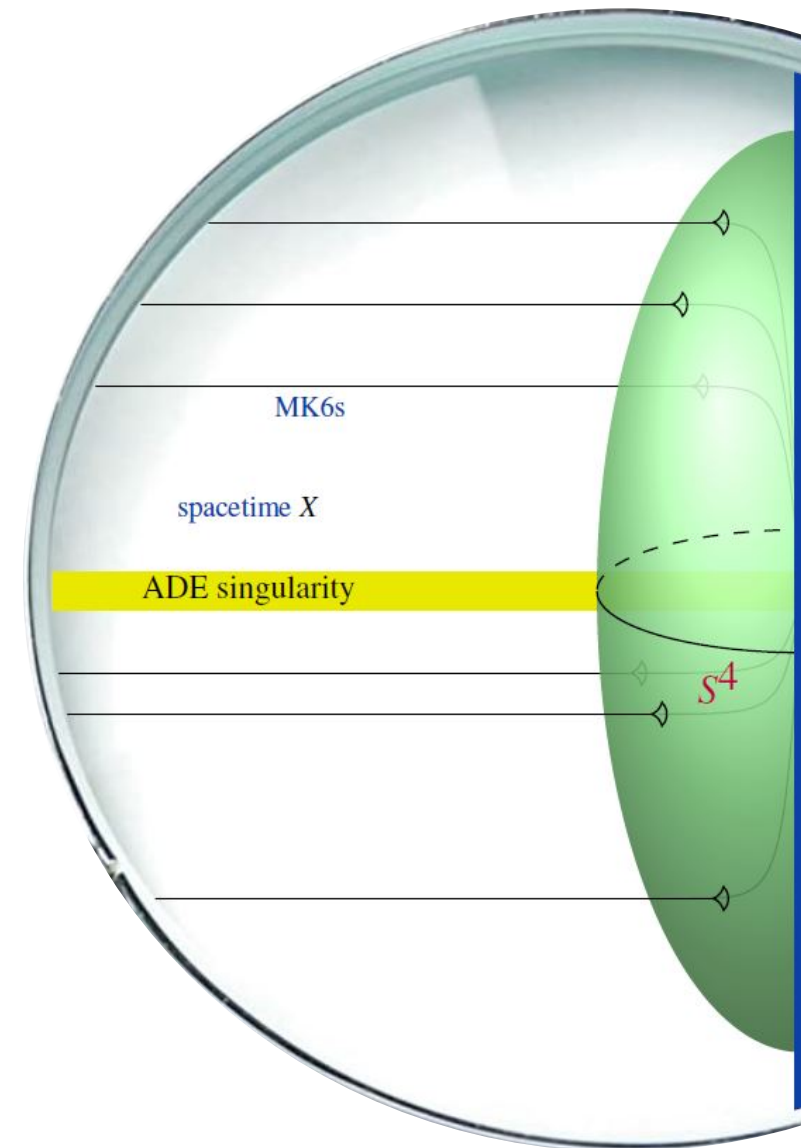



While perturbative string theory is  $\sim$  well-defined (via worldsheet SCFT), defining non-perturbative brane physics (M-theory) has remained an open problem.

**Hypothesis H** is a new proposal for the mathematical definition of the quantum states/charges of M-theory

in the vein of two previous proposals for string theory:

- a) derived categories with Bridgeland-stability,
- b) twisted topological K-theory.

**Hypothesis H** combines:

- the higher homotopy category theory of (a)
  - the generalized cohomology theory of (b)
- but made (a) *non-linear* and (b) *non-abelian*.

**Hypothesis H** asserts, in short, that:

*M-brane charge is quantized in*

*J-twisted 4-Cohomotopy theory.*

**This talk surveys what this means** and how this

- 1) is made precise over orbi-super-spacetimes;
- 2) implies conjectured fractional M5 tadpole cancellation (& more).

For more see H. Sati's talks and see: [ncatlab.org/schreiber/show/Hypothesis+H](https://ncatlab.org/schreiber/show/Hypothesis+H)

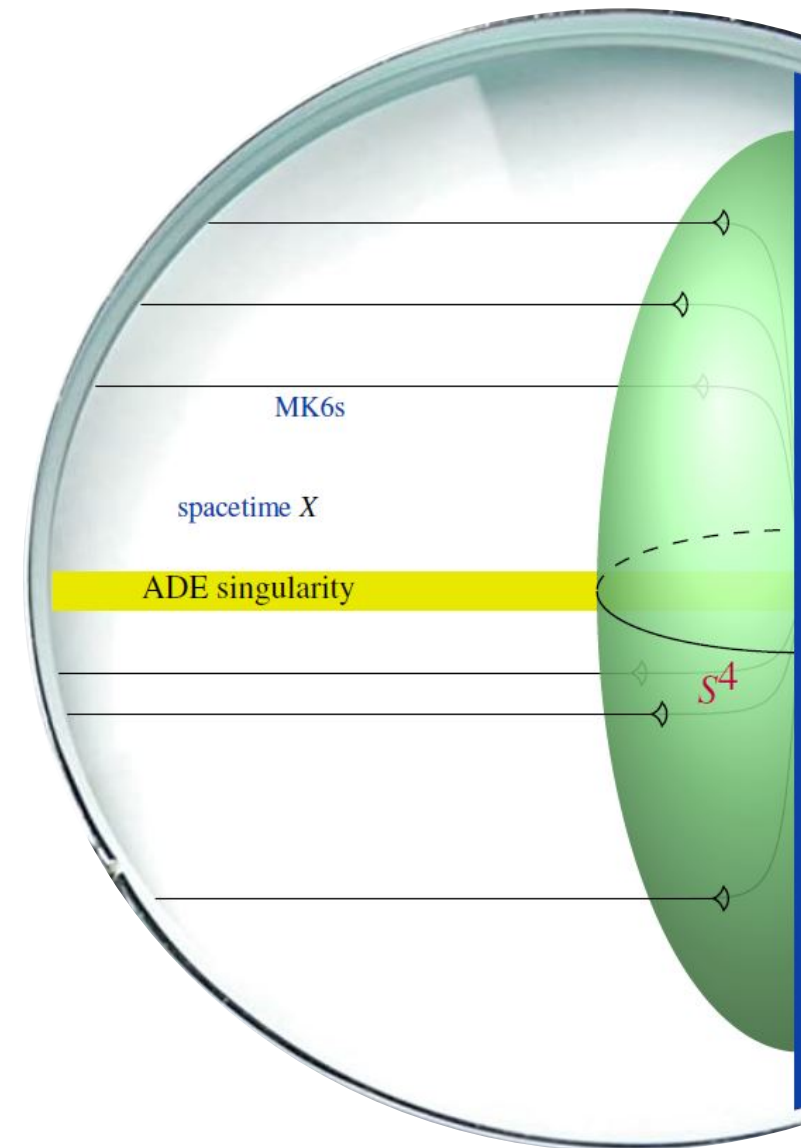



higher orbi-geometry

orbifold cohomology

I – Proper Orbifold Cohomotopy

II – for M-Theory

Hypothesis H

M5-brane charges in  
flat orbi-orientifolds

*String theory at its finest is, or should be, a new branch of geometry  
... developed in the 21st century ... that fell by chance into the 20th century ...*

*To elucidate the proper generalization of geometry  
[is] the central problem of string theory.*

E. Witten (1988)

as quoted on p. 95, 102 in:

P C W Davis and J Brown (eds.)

*Superstrings: A theory of everything?*

Camb Univ Press 1988, 1991: Canto 1992

What does it even *mean* to define a non-perturbative quantum theory?

What does it even *mean* to define a non-perturbative quantum theory?

Lots of subtleties, but two general principles:

- 1) covariant phase space of *all* field histories (all instanton/soliton sectors)
- 2) quantum states are *global* sections of prequantum line bundle over phase space

Hence we need a geometry which makes sense of symbols like this:

What does it even *mean* to define a non-perturbative quantum theory?

Lots of subtleties, but two general principles:

- 1) covariant phase space of *all* field histories (all instanton/soliton sectors)
- 2) quantum states are *global* sections of prequantum line bundle over phase space

Hence we need a geometry which makes sense of symbols like this:

spacetime
super orbi-fold
 $\mathcal{X},$ 
higher stack
 $\mathcal{A} \in \mathbf{H}$ 
field moduli
21st geometry
 $\vdash$

What does it even *mean* to define a non-perturbative quantum theory?

Lots of subtleties, but two general principles:

- 1) covariant phase space of *all* field histories (all instanton/soliton sectors)
- 2) quantum states are *global* sections of prequantum line bundle over phase space

Hence we need a geometry which makes sense of symbols like this:

$$\begin{array}{c}
 \text{super orbi-fold} \\
 \text{higher stack}
 \end{array}
 \mathcal{X},
 \begin{array}{c}
 \text{spacetime} \\
 \mathcal{A}
 \end{array}
 \in
 \begin{array}{c}
 \text{field moduli} \\
 \mathbf{H} \\
 \infty\text{-topos}
 \end{array}
 \vdash
 \begin{array}{c}
 \text{21st geometry}
 \end{array}$$

What does it even *mean* to define a non-perturbative quantum theory?

Lots of subtleties, but two general principles:

- 1) covariant phase space of *all* field histories (all instanton/soliton sectors)
- 2) quantum states are *global* sections of prequantum line bundle over phase space

Hence we need a geometry which makes sense of symbols like this:

$$\begin{array}{c}
 \text{super orbi-fold} \\
 \text{higher stack}
 \end{array}
 \mathcal{X},
 \begin{array}{c}
 \text{spacetime} \\
 \text{field moduli}
 \end{array}
 \mathcal{A}
 \in
 \begin{array}{c}
 \mathbf{H} \\
 \infty\text{-topos}
 \end{array}
 \vdash
 \begin{array}{c}
 \text{21st geometry} \\
 \text{ab. cohomology}
 \end{array}
 \hat{H}_{\text{pos}}^{\bullet}
 \left(
 \begin{array}{c}
 \text{quantum states} \\
 \text{mapping stack} \\
 \text{cocycles of higher} \\
 \text{diff. non-ab. cohom.}
 \end{array}
 \text{Map}^*
 \left(
 \begin{array}{c}
 \text{phase space of} \\
 \text{field histories}
 \end{array}
 \mathcal{X},
 \mathcal{A}
 \right)
 \right)$$



What does it even *mean* to define a non-perturbative quantum theory?

Lots of subtleties, but two general principles:

- 1) covariant phase space of *all* field histories (all instanton/soliton sectors)
- 2) quantum states are *global* sections of prequantum line bundle over phase space

Hence we need a geometry which makes sense of symbols like this:

$$\begin{array}{c}
 \text{super orbi-fold} \\
 \text{higher stack}
 \end{array}
 \mathcal{X},
 \begin{array}{c}
 \text{spacetime} \\
 \text{field moduli}
 \end{array}
 \mathcal{A}
 \in
 \begin{array}{c}
 \mathbf{H} \\
 \infty\text{-topos}
 \end{array}
 \vdash
 \begin{array}{c}
 \text{21st geometry} \\
 \text{ab. cohomology}
 \end{array}
 \hat{H}_{\text{pos}}^{\bullet}
 \left(
 \begin{array}{c}
 \text{quantum states} \\
 \text{mapping stack} \\
 \text{cocycles of higher} \\
 \text{diff. non-ab. cohom.}
 \end{array}
 \text{Map}^*
 \left(
 \begin{array}{c}
 \text{phase space of} \\
 \text{field histories}
 \end{array}
 \mathcal{X}, \mathcal{A}
 \right)
 \right)$$

Ex.: 3d CS theory with cpt gauge group:  
 [Hit90] [APW91]

---

$\mathcal{X}$  = surface  
 $\mathcal{A}$  = moduli stack of (flat) connections  
 $\hat{H}_{\text{pos}}^{\bullet}$  = hol. sections of prequ. line bdl.

What does it even *mean* to define a non-perturbative quantum theory?

Lots of subtleties, but two general principles:

- 1) covariant phase space of *all* field histories (all instanton/soliton sectors)
- 2) quantum states are *global* sections of prequantum line bundle over phase space

Hence we need a geometry which makes sense of symbols like this:

$$\begin{array}{c}
 \text{super orbi-fold} \\
 \text{higher stack} \\
 \mathcal{X}, \mathcal{A} \in \mathbf{H} \\
 \infty\text{-topos}
 \end{array}
 \begin{array}{c}
 \text{spacetime} \\
 \text{field moduli} \\
 \text{21st geometry}
 \end{array}
 \vdash
 \begin{array}{c}
 \text{ab. cohomology} \\
 \text{mapping stack} \\
 \text{cocycles of higher} \\
 \text{diff. non-ab. cohom.} \\
 \widehat{H}_{\text{pos}}^{\bullet} \left( \text{Map}^* (\mathcal{X}, \mathcal{A}) \right)
 \end{array}
 \begin{array}{c}
 \text{quantum states} \\
 \text{phase space of} \\
 \text{field histories}
 \end{array}$$

Ex.: 3d CS theory with cpt gauge group:  
 [Hit90] [APW91]

---

$\mathcal{X}$  = surface  
 $\mathcal{A}$  = moduli stack of (flat) connections  
 $\widehat{H}_{\text{pos}}^{\bullet}$  = hol. sections of prequ. line bdl.

Ex.: D6  $\perp$  D8-branes via Hypothesis H  
 [SS19-Quant][CSS21-Quant]

---

$\mathcal{X}$  = transverse cptfd. space to branes  
 $\mathcal{A}$  = moduli stack of diff. 4-Cohomotopy  
 $\widehat{H}_{\text{pos}}^{\bullet}$  = positive ordinary cohomology

The dictionary:

**physics**

**mathematics**

geometry

topos theory

+ gauge principle

homotopy theory

=

$\infty$ -topos theory [Si99][Lu03,09][TV05][Re10]

The dictionary:

**physics**

**mathematics**

geometry

topos theory

+ gauge principle

homotopy theory

=

$\infty$ -topos theory [Si99][Lu03,09][TV05][Re10]

The jargon:

$$\mathcal{X}, \mathcal{A} \in \mathbf{H} \simeq \text{Sh}_\infty(\mathbf{S})$$

(examples follow)

$\infty$ -topos

$\infty$ -stacks

$\infty$ -site

21st geometry

high. geom. spaces

local model geom.

# The Higher Geometry of Physics.

[JSSW18-HigStrc][FSS19-RatM][SS20-OrbCoh]

The dictionary:

**physics**

**mathematics**

geometry

topos theory

+ gauge principle

homotopy theory

=

$\infty$ -topos theory [Si99][Lu03,09][TV05][Re10]

The jargon:

$$\mathcal{X}, \mathcal{A} \in \mathbf{H} \simeq \text{Sh}_\infty(\mathbf{S})$$

$\infty$ -topos

$\infty$ -stacks

$\infty$ -site

21st geometry

high. geom. spaces

local model geom.

(examples follow)

The key point:

**stringy geometry**

$\leftrightarrow$

**higher homotopy**

$p$ -brane charges

$\pi_{p+1}(\mathcal{A}) \in \text{Grp}(\mathbf{H}_0)$

$p_1 \perp p_2$ -intersections

higher k-invariants

[FSS13-Bouq, §3]

[HSS18-ADE, §2]

[FSS19-RatM, §7]

$$\Sigma \in \mathbf{S}, \quad \mathcal{X} \in \mathbf{H}$$

*representable* *probe worldvol.* *higher stack* *gauged target sp.*

The idea:

Just as an emergent target space  $\mathcal{X}$  seen via probes by worldvolumes  $\Sigma$ ,  
so an  $\infty$ -**stack**  $\mathcal{X}$  is a space bootstrapped by its gauged system of  $\Sigma$ -plots:

$\Sigma \in \mathbf{S}, \quad \mathcal{X} \in \mathbf{H}$

*representable*      *probe worldvol.*      *higher stack*      *gauged target sp.*

The idea:

Just as an emergent target space  $\mathcal{X}$  seen via probes by worldvolumes  $\Sigma$ ,  
 so an  $\infty$ -**stack**  $\mathcal{X}$  is a space bootstrapped by its gauged system of  $\Sigma$ -plots:

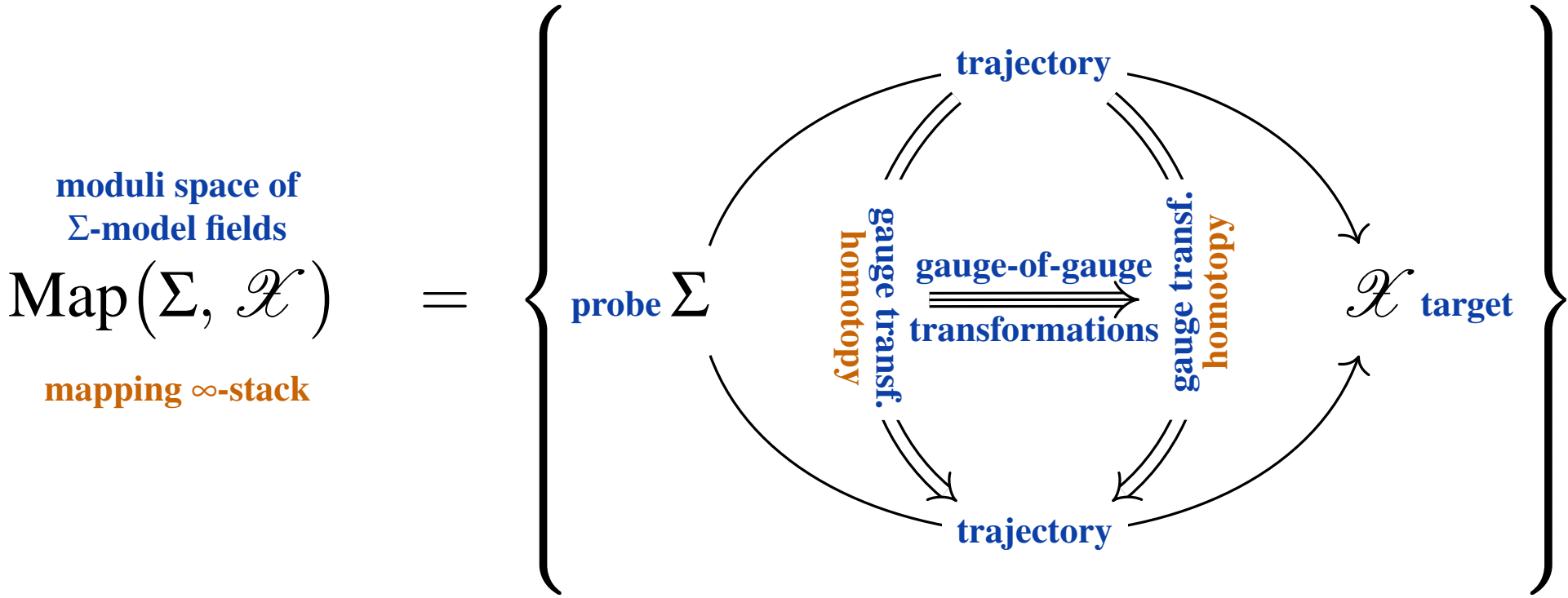



Key example: Higher geometry locally modeled on  $\text{CartSp} = \{ \mathbb{R}^n \xrightarrow{\text{smooth}} \mathbb{R}^{n'} \}$ :

$$\mathbf{H} = \text{SmthGrpd}_\infty := \text{Sh}_\infty(\text{CartSp}) \simeq \text{Sh}_\infty(\text{SmthMfd})$$

faithfully subsumes all differential topology:

# Cohesive homotopy theory of Smooth $\infty$ -stacks.

[SSS09][Sc13][ScSh14][SS20-OrbCoh]

Key example: Higher geometry locally modeled on  $\text{CartSp} = \{ \mathbb{R}^n \xrightarrow{\text{smooth}} \mathbb{R}^{n'} \}$ :

$$\mathbf{H} = \text{SmthGrpd}_\infty := \text{Sh}_\infty(\text{CartSp}) \simeq \text{Sh}_\infty(\text{SmthMfd})$$

faithfully subsumes all differential topology:

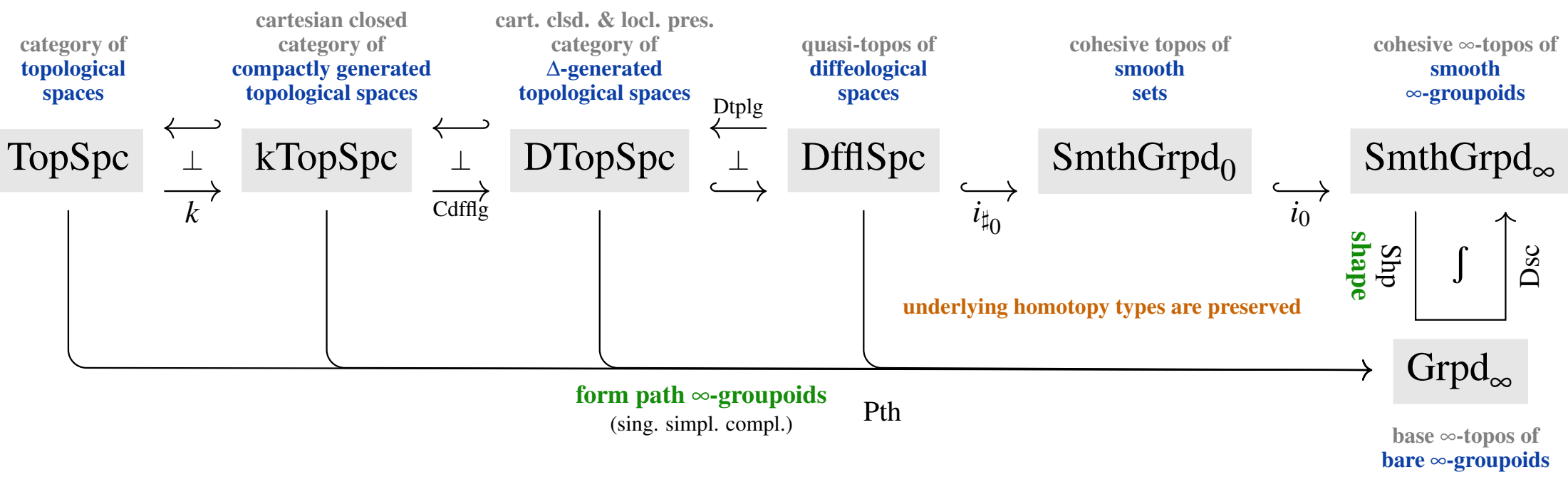

Key example: Higher geometry locally modeled on  $\text{CartSp} = \{ \mathbb{R}^n \xrightarrow{\text{smooth}} \mathbb{R}^{n'} \}$ :

$$\mathbf{H} = \text{SmthGrpd}_\infty := \text{Sh}_\infty(\text{CartSp}) \simeq \text{Sh}_\infty(\text{SmthMfd})$$

faithfully subsumes all differential topology:

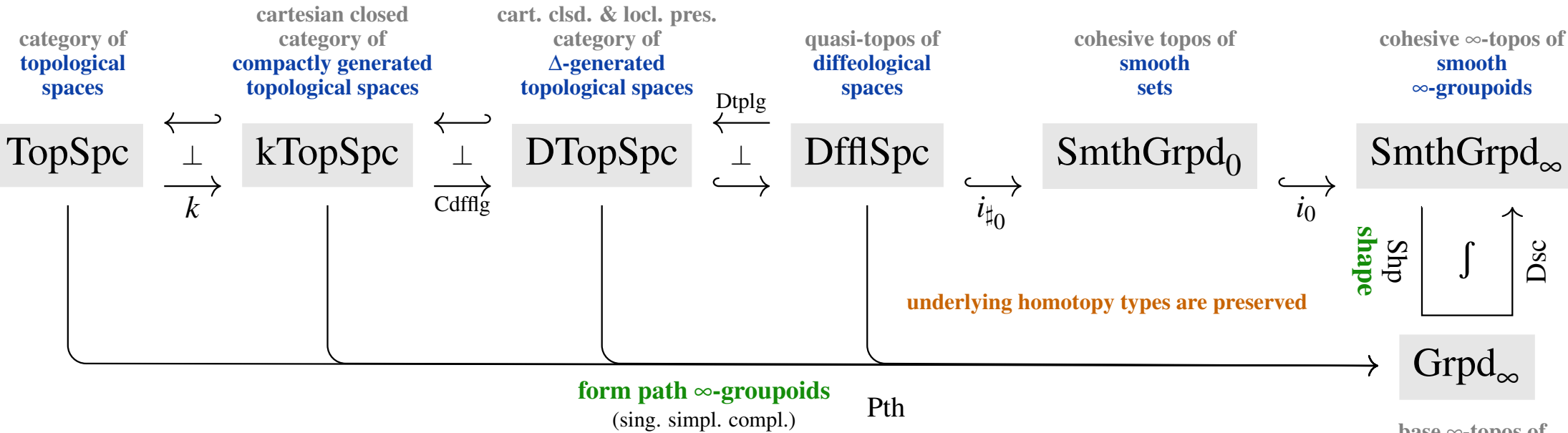

but subsumes also moduli for all

**higher gauge fields**  $\leftrightarrow$  **differential cohomology** [FSS20-Char, §4.3]

in particular for *abelian* higher gauge fields:

$$\text{Spectra}(\text{SmthGrpd}_\infty) = \left\{ \begin{array}{l} \text{abelian generalized differential} \\ \text{cohomology theories} \end{array} \right\} \quad \begin{array}{l} [\text{Sc13}] [\text{BNV14}], \\ \text{review in } [\text{ADH21}] \end{array}$$

# Higher symmetry.

$\infty$ -Toposes  $\mathbf{H}$  know all about *higher symmetries* – i.e. *n-group symmetries* for  $n \in \mathbb{N} \sqcup \{\infty\}$ ):

higher groups

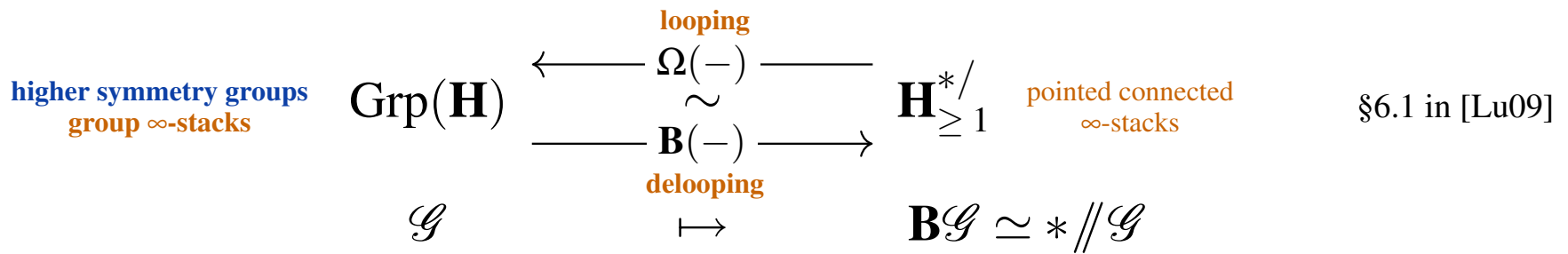

∞-Toposes **H** know all about *higher symmetries* – i.e. *n-group symmetries* for  $n \in \mathbb{N} \sqcup \{\infty\}$ ):

higher groups

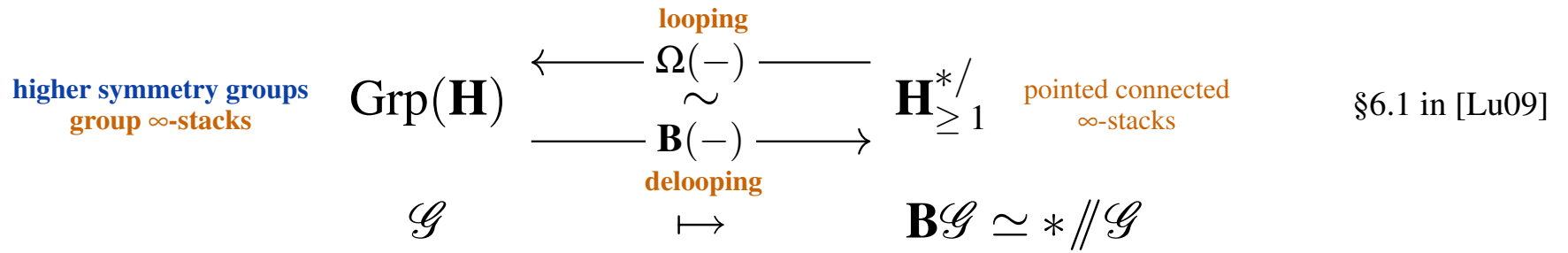

higher symmetries

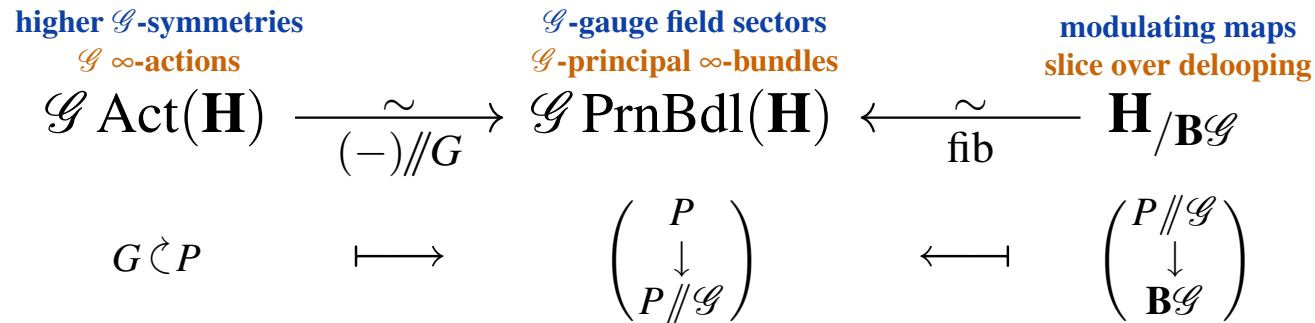

# Higher symmetry.

∞-Toposes **H** know all about *higher symmetries* – i.e. *n-group symmetries* for  $n \in \mathbb{N} \sqcup \{\infty\}$ ):

higher groups

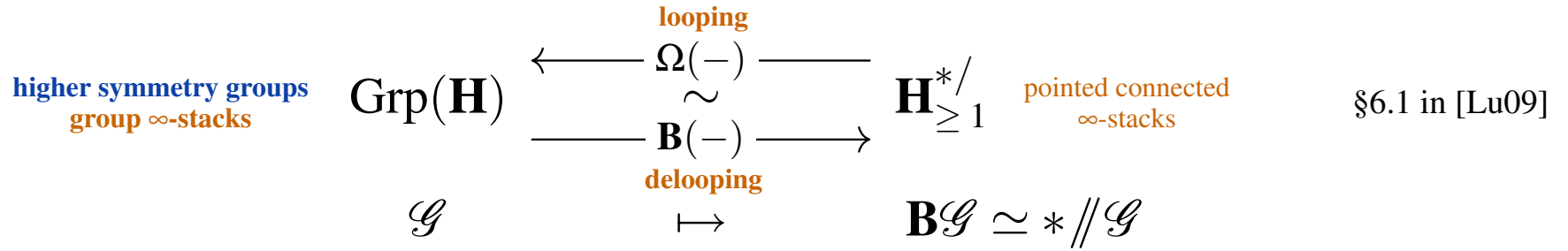

higher symmetries

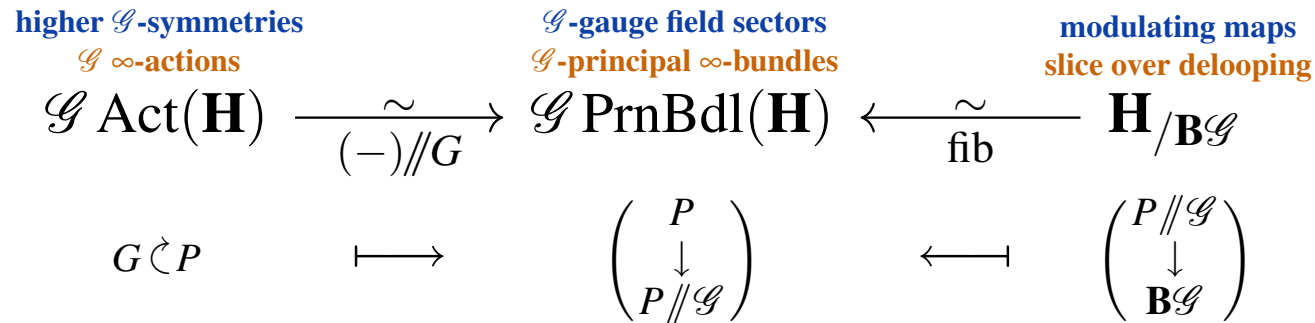

Technical side remark. – The correspondence is enacted by homotopy cartesian squares of this form:

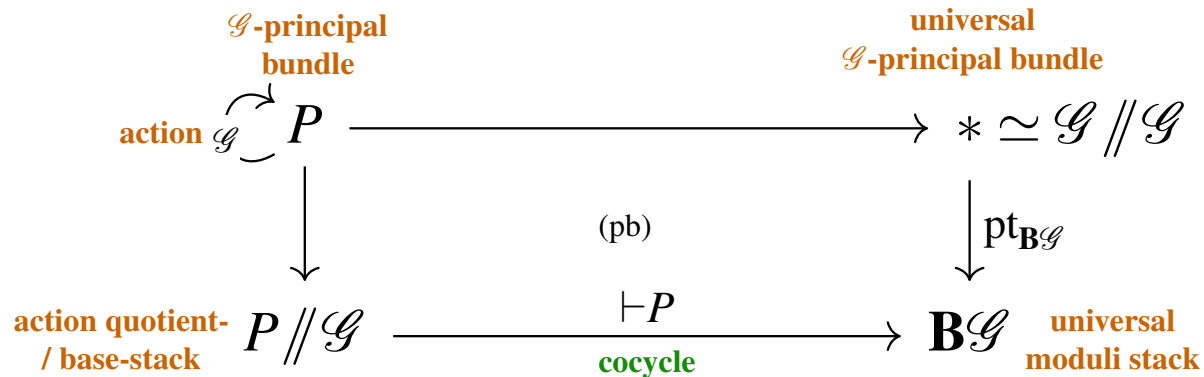

Maps *out* of an  $\infty$ -stack  $\mathcal{X} \rightarrow \mathcal{A}$  encode  $\mathcal{A}$ -moduli on  $\mathcal{X}$ :

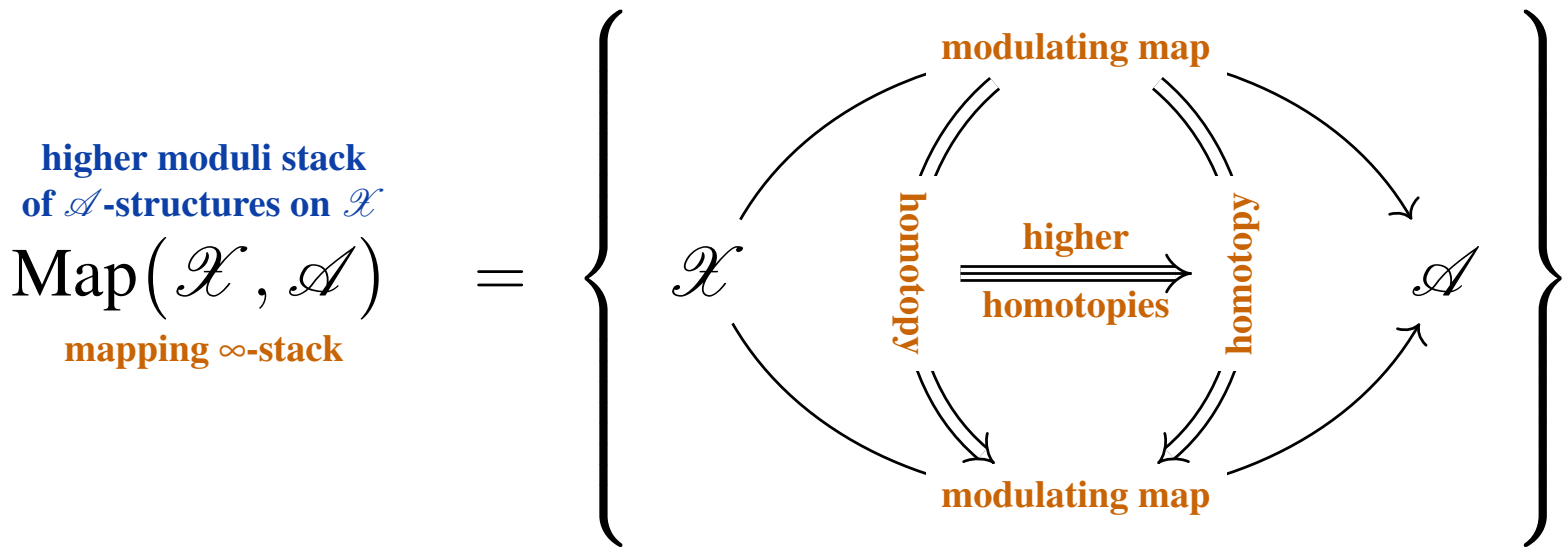

Ex.:  $\text{Map}(\mathcal{X}, \mathbf{BG})$  is the moduli  $\infty$ -stack of  $\mathcal{G}$ -principal  $\infty$ -bundles on  $\mathcal{X}$  (high. gauge field sect.)



Maps *out* of an  $\infty$ -stack  $\mathcal{X} \rightarrow \mathcal{A}$  encode  $\mathcal{A}$ -moduli on  $\mathcal{X}$ :

$$\text{higher moduli stack of } \mathcal{A}\text{-structures on } \mathcal{X} \\ \text{mapping } \infty\text{-stack} \\ \text{Map}(\mathcal{X}, \mathcal{A}) = \left\{ \begin{array}{ccc} & \text{modulating map} & \\ \mathcal{X} & \begin{array}{c} \text{homotopy} \\ \text{higher} \\ \text{homotopies} \\ \text{homotopy} \end{array} & \mathcal{A} \\ & \text{modulating map} & \end{array} \right\}$$

Ex.:  $\text{Map}(\mathcal{X}, \mathbf{BG})$  is the moduli  $\infty$ -stack of  $\mathcal{G}$ -principal  $\infty$ -bundles on  $\mathcal{X}$  (high. gauge field sect.)

Fund. Thm. [Lu09]: for  $\mathcal{B} \in \mathbf{H}$  also  $\mathbf{H}_{/\mathcal{B}}$  is an  $\infty$ -topos, whose objects are maps  $\mathcal{X} \xrightarrow{c} \mathcal{B}$ , with

$$\text{slice mapping } \infty\text{-stack} \\ \text{Map}((\mathcal{X}, c), (\mathcal{A}, c'))_{\mathcal{B}} = \left\{ \begin{array}{ccc} & & \\ \mathcal{X} & \begin{array}{c} \text{homotopy} \\ \text{higher} \\ \text{homotopies} \\ \text{homotopy} \end{array} & \mathcal{A} \\ & \begin{array}{c} c \\ \text{homotopy} \\ c' \end{array} & \mathcal{B} \end{array} \right\}.$$

Ex.:  $\text{Map}(\mathcal{X}, \mathbf{BG})_{\mathbf{B}\mathcal{L}}$  is moduli  $\infty$ -stack of  $\mathcal{G}$ -structures on  $\mathcal{L}$ -bundles (gravity/metrics, below)

**Higher symmetry – Example: GS-mechanism. [SSS09][FSS12][FSS20-M5Str][SS20-M5GS]**

Lie groups

diffeological groups

smooth  $\infty$ -groups

Under  $\text{Grp}(\text{SmthMfd}) \hookrightarrow \text{Grp}(\text{DfflSpc}) \xleftarrow{\text{Grp}(i_0, \#_0)} \text{Grp}(\text{SmthGrpd}_\infty)$

**mapping stack into delooping...**

**is moduli stack of:**

---

---

---

---

---

---

---

---

---

---

**Higher symmetry – Example: GS-mechanism. [SSS09][FSS12][FSS20-M5Str][SS20-M5GS]**

Lie groups

diffeological groups

smooth  $\infty$ -groups

Under  $\text{Grp}(\text{SmthMfd}) \hookrightarrow \text{Grp}(\text{DfflSpc}) \xleftarrow{\text{Grp}(i_0, \#_0)} \text{Grp}(\text{SmthGrpd}_\infty)$

**mapping stack into delooping...**

**is moduli stack of:**

---

---

$\text{Map}(X, \mathbf{BU}(1))$

---

---

circle bundles

---

---

---

---

---

---

---

---

**Higher symmetry – Example: GS-mechanism. [SSS09][FSS12][FSS20-M5Str][SS20-M5GS]**

Lie groups

diffeological groups

smooth  $\infty$ -groups

Under  $\text{Grp}(\text{SmthMfd}) \hookrightarrow \text{Grp}(\text{DfflSpc}) \xleftarrow{\text{Grp}(i_0, \#_0)} \text{Grp}(\text{SmthGrpd}_\infty)$

**mapping stack into delooping...**

**is moduli stack of:**

---

$\text{Map}(X, \mathbf{BU}(1))$

circle bundles

---

$\text{Map}(X, \mathbf{B}^{p+1}\mathbf{U}(1))$

bundle  $p$ -gerbes

---



---



---



---

**Higher symmetry – Example: GS-mechanism.** [SSS09][FSS12][FSS20-M5Str][SS20-M5GS]

Lie groups

diffeological groups

smooth  $\infty$ -groups

Under  $\text{Grp}(\text{SmthMfd}) \hookrightarrow \text{Grp}(\text{DfflSpc}) \xrightarrow{\text{Grp}(i_0, \#_0)} \text{Grp}(\text{SmthGrpd}_\infty)$

**mapping stack into delooping...**

**is moduli stack of:**

$\text{Map}(X, \mathbf{B}U(1))$	circle bundles
$\text{Map}(X, \mathbf{B}^{p+1}U(1))$	bundle $p$ -gerbes
$\text{Map}(X, \mathbf{B}\text{Spin}(n))$	Spin-bundles

**Higher symmetry – Example: GS-mechanism.** [SSS09][FSS12][FSS20-M5Str][SS20-M5GS]

**Lie groups**
**diffeological groups**
**smooth  $\infty$ -groups**

Under  $\text{Grp}(\text{SmthMfd}) \hookrightarrow \text{Grp}(\text{DfflSpc}) \xrightarrow{\text{Grp}(i_0, \#_0)} \text{Grp}(\text{SmthGrpd}_\infty)$

**mapping stack into delooping...**

**is moduli stack of:**

$\text{Map}(X, \mathbf{BU}(1))$	circle bundles
$\text{Map}(X, \mathbf{B}^{p+1}\mathbf{U}(1))$	bundle $p$ -gerbes
$\text{Map}(X, \mathbf{BSpin}(n))$	Spin-bundles
$\text{Map}((X, \mathbf{c}_1), (\mathbf{BSO}(n), \mathbf{w}_2))_{\mathbf{BU}(1)}$ $\simeq \text{Map}(X, \mathbf{BSpin}^{\mathbf{c}_1}(n))$	$\text{Spin}^c$ -bundles

**Higher symmetry – Example: GS-mechanism.** [SSS09][FSS12][FSS20-M5Str][SS20-M5GS]

Lie groups                      diffeological groups                      smooth  $\infty$ -groups  
 Under  $\text{Grp}(\text{SmthMfd}) \hookrightarrow \text{Grp}(\text{DfflSpc}) \xleftarrow{\text{Grp}(i_0, \#_0)} \text{Grp}(\text{SmthGrpd}_\infty)$

**mapping stack into delooping...**

**is moduli stack of:**

$\text{Map}(X, \mathbf{BU}(1))$	circle bundles
$\text{Map}(X, \mathbf{B}^{p+1}\mathbf{U}(1))$	bundle $p$ -gerbes
$\text{Map}(X, \mathbf{BSpin}(n))$	Spin-bundles
$\text{Map}((X, \mathbf{c}_1), (\mathbf{BSO}(n), \mathbf{w}_2))_{\mathbf{BU}(1)}$ $\simeq \text{Map}(X, \mathbf{BSpin}^{\mathbf{c}_1}(n))$	Spin <sup>c</sup> -bundles
$\text{Map}((X, 0), (\mathbf{BSpin}(n), \frac{1}{2}p_1))_{\mathbf{B}^3\mathbf{U}(1)}$ $\simeq \text{Map}(X, \mathbf{BString}(n))$	String 2-bundles

**Higher symmetry – Example: GS-mechanism.** [SSS09][FSS12][FSS20-M5Str][SS20-M5GS]

Lie groups                      diffeological groups                      smooth  $\infty$ -groups

$$\text{Under } \text{Grp}(\text{SmthMfd}) \hookrightarrow \text{Grp}(\text{DfflSpc}) \xleftarrow{\text{Grp}(i_0, \#_0)} \text{Grp}(\text{SmthGrpd}_\infty)$$

**mapping stack into delooping...**

**is moduli stack of:**

$\text{Map}(X, \mathbf{BU}(1))$	circle bundles
$\text{Map}(X, \mathbf{B}^{p+1}\mathbf{U}(1))$	bundle $p$ -gerbes
$\text{Map}(X, \mathbf{BSpin}(n))$	Spin-bundles
$\text{Map}((X, \mathbf{c}_1), (\mathbf{BSO}(n), \mathbf{w}_2))_{\mathbf{BU}(1)}$ $\simeq \text{Map}(X, \mathbf{BSpin}^{\mathbf{c}_1}(n))$	$\text{Spin}^c$ -bundles
$\text{Map}((X, 0), (\mathbf{BSpin}(n), \frac{1}{2}\mathbf{p}_1))_{\mathbf{B}^3\mathbf{U}(1)}$ $\simeq \text{Map}(X, \mathbf{BString}(n))$	String 2-bundles
$\text{Map}((X, \mathbf{c}_2), (\mathbf{BSpin}(n), \frac{1}{2}\mathbf{p}_1))_{\mathbf{B}^3\mathbf{U}(1)}$ $\simeq \text{Map}(X, \mathbf{BString}^{\mathbf{c}_2}(n))$	twisted String 2-bundles (heterotic Green-Schwarz mech.)



# Higher symmetry – Example: GS-mechanism. [SSS09][FSS12][FSS20-M5Str][SS20-M5GS]

$$\text{Under } \begin{array}{c} \text{Lie groups} \\ \text{Grp}(\text{SmthMfd}) \end{array} \begin{array}{c} \longleftarrow \\ \longrightarrow \end{array} \begin{array}{c} \text{diffeological groups} \\ \text{Grp}(\text{DfflSpc}) \end{array} \begin{array}{c} \longleftarrow \\ \longrightarrow \end{array} \begin{array}{c} \text{smooth } \infty\text{-groups} \\ \text{Grp}(\text{SmthGrpd}_\infty) \end{array}$$

mapping stack into delooping...

is moduli stack of:

$$\text{Map}(X, \mathbf{BU}(1))$$

circle bundles

$$\text{Map}(X, \mathbf{B}^{p+1}\mathbf{U}(1))$$

bundle  $p$ -gerbes

$$\text{Map}(X, \mathbf{B}\text{Spin}(n))$$

Spin-bundles

$$\text{Map}((X, \mathbf{c}_1), (\mathbf{BSO}(n), \mathbf{w}_2))_{\mathbf{BU}(1)}$$

$\text{Spin}^c$ -bundles

$$\simeq \text{Map}(X, \mathbf{B}\text{Spin}^{\mathbf{c}_1}(n))$$

$$\text{Map}((X, 0), (\mathbf{B}\text{Spin}(n), \frac{1}{2}p_1))_{\mathbf{B}^3\mathbf{U}(1)}$$

String 2-bundles

$$\simeq \text{Map}(X, \mathbf{B}\text{String}(n))$$

$$\text{Map}((X, \mathbf{c}_2), (\mathbf{B}\text{Spin}(n), \frac{1}{2}\mathbf{p}_1))_{\mathbf{B}^3\mathbf{U}(1)}$$

twisted String 2-bundles  
(heterotic Green-Schwarz mech.)

$$\simeq \text{Map}(X, \mathbf{B}\text{String}^{\mathbf{c}_2}(n))$$

**Rem.:** Different smooth  $\infty$ -groups  $\mathcal{G}$  may have same shape  $\int \mathcal{G}$  discrete  $\infty$ -group, e.g:

$$\mathbf{BPU}_\omega \xrightarrow{\eta^f} \mathbf{B}^3\mathbb{Z} \xleftarrow{\eta^f} \mathbf{B}^2\mathbf{U}(1)$$

$$\quad \quad \quad \wr \downarrow$$

$$\quad \quad \quad K(\mathbb{Z}, 3)$$

## Higher symmetry – Example: Cohomotopy.

Exs. 2.10, 2.16, 4.16 in [FSS20-Char]

Recall that *every connected* space is the classifying space of its loop  $\infty$ -group.

E.g., the 4-sphere encodes a rich  $\infty$ -higher symmetry

$$S^4 \simeq B(\Omega S^4) \in \mathbf{Grpd}_\infty, \quad \Omega S^4 \in \mathbf{Grp}(\mathbf{Grpd}_\infty).$$

## Higher symmetry – Example: Cohomotopy.

Exs. 2.10, 2.16, 4.16 in [FSS20-Char]

Recall that *every connected* space is the classifying space of its loop  $\infty$ -group.

E.g., the 4-sphere encodes a rich  $\infty$ -higher symmetry

$$S^4 \simeq B(\Omega S^4) \in \mathbf{Grpd}_\infty, \quad \Omega S^4 \in \mathbf{Grp}(\mathbf{Grpd}_\infty).$$

The corresponding moduli are classified by unstable/non-abelian **Cohomotopy**:

$$\pi^4(\mathbf{X}) := \pi_0 \mathbf{Map}(\mathbf{X}, S^4) \simeq \pi_0 \mathbf{Map}(\mathbf{X}, B(\Omega S^4)) \simeq H^1(\mathbf{X}; \Omega S^4)$$

4-Cohomotopy

non-abelian  
cohomology  
with coefficients in  
loop  $\infty$ -group

# Higher symmetry – Example: Cohomotopy.

Exs. 2.10, 2.16, 4.16 in [FSS20-Char]

Recall that *every connected* space is the classifying space of its loop  $\infty$ -group.

E.g., the 4-sphere encodes a rich  $\infty$ -higher symmetry

$$S^4 \simeq B(\Omega S^4) \in \text{Grpd}_\infty, \quad \Omega S^4 \in \text{Grp}(\text{Grpd}_\infty).$$

The corresponding moduli are classified by unstable/non-abelian **Cohomotopy**:

$$\pi^4(X) := \pi_0 \text{Map}(X, S^4) \simeq \pi_0 \text{Map}(X, B(\Omega S^4)) \simeq H^1(X; \Omega S^4)$$

4-Cohomotopy

non-abelian  
cohomology  
with coefficients in  
loop  $\infty$ -group

Incidentally, on 10-manifolds  $X^{10}$ , 4-Cohomotopy is stably equivalent to  $\text{tmf}^4$  (cf below):

$$\begin{array}{ccccc}
 S^4 & \xrightarrow{\quad\quad\quad} & \Omega^\infty \Sigma^\infty S^4 = \Omega^\infty S^4 & \xrightarrow[\sim_{\leq 10}]{\beta} & \Omega^\infty \text{tmf}^4 \\
 & & \text{stabilization/} & & \text{Boardman homomorphism} \\
 & & \text{abelianization} & & \\
 \pi^4(\mathbb{R}^{0,1} \times X^{10}) & \xrightarrow{\quad\quad\quad} & S^4(\mathbb{R}^{0,1} \times X^{10}) & \xrightarrow{\sim} & \text{tmf}^4(\mathbb{R}^{0,1} \times X^{10}) \\
 \text{unstable/} & & \text{stable/} & & \text{elliptic 4-cohomology} \\
 \text{non-abelian} & \text{4-Cohomotopy} & \text{abelianized} & \text{4-Cohomotopy} & 
 \end{array}$$

Higher geometry locally modeled on

$$\text{SupCartSp} = \left\{ \mathbb{R}^{n|q} \times \mathbb{D} \xrightarrow{\text{smooth}} \mathbb{R}^{n'|q'} \times \mathbb{D}' \right\}$$

super-Cartesian space
infinitesimal disk

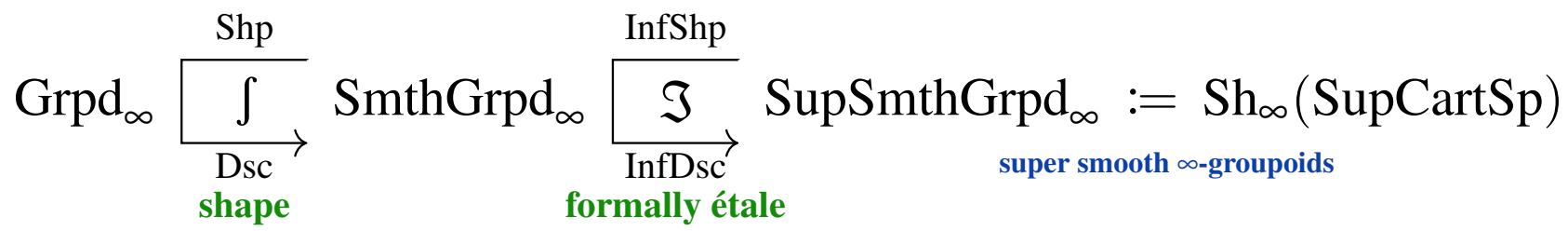

lifts all fundamentals of differential geometry to higher geometry of super  $\infty$ -stacks, e.g.:

Higher geometry locally modeled on

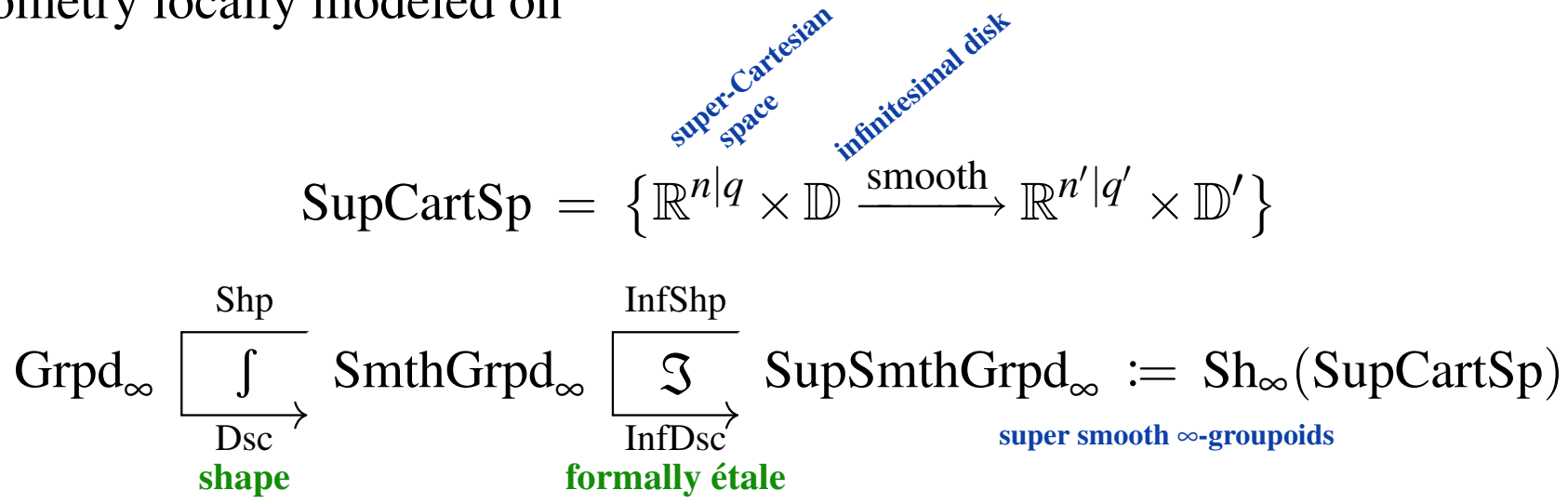

lifts all fundamentals of differential geometry to higher geometry of super  $\infty$ -stacks, e.g.:

<p>A morphism of super <math>\infty</math>-stacks is a <b>local diffeomorphism</b> or <i>formally étale</i> if its <math>\mathfrak{S}</math>-unit is homotopy cartesian:</p>	$\begin{array}{ccc} X & \xrightarrow{\eta^{\mathfrak{S}}} & \mathfrak{S}X \\ f \downarrow \text{ét} & \text{(pb)} & \downarrow \mathfrak{S}f \\ Y & \xrightarrow{\eta^{\mathfrak{S}}} & \mathfrak{S}Y \end{array}$
<p>The <b>infinitesimal neighbourhood</b> around point <math>x</math> in a super <math>\infty</math>-stack <math>X</math> is the <math>x</math>-fiber of the <math>\mathfrak{S}</math>-unit:</p>	$\begin{array}{ccc} \mathbb{D}_x X & \longrightarrow & * \\ \downarrow & \text{(pb)} & \downarrow \mathfrak{S}_x \\ X & \xrightarrow{\eta^{\mathfrak{S}}} & \mathfrak{S}X \end{array}$

For  $V \in \text{Grp}(\text{SupSmthGrpd}_\infty)$  a super group stack such as super-Minkowski  $V = \mathbb{R}^{d,1|\mathbf{N}}$ :

**Def.:** A  $V$ -fold is an étale  $\infty$ -stack locally diffeomorphic to  $V \xleftarrow[\text{ét}]{V\text{-atlas}} U \xrightarrow[\text{eff.epi}]{V\text{-fold}} X$ .

(This cohesive **higher Cartan geometry** is formalized in Modal Homotopy Type Theory:  
[Sc15, §3][Cherubini (né Wellen) 17].)

For  $V \in \text{Grp}(\text{SupSmthGrpd}_\infty)$  a super group stack such as super-Minkowski  $V = \mathbb{R}^{d,1|\mathbf{N}}$ :

**Def.:** A  $V$ -fold is an étale  $\infty$ -stack locally diffeomorphic to  $V \xleftarrow[\text{ét}]{V\text{-atlas}} U \xrightarrow[\text{eff.epi}]{V\text{-fold}} X$ .

**Thm.:** A  $V$ -fold  $X$  naturally has a **frame  $\infty$ -bundle**  $X \xrightarrow{\vdash \text{Fr}(X)} \mathbf{BAut}(\mathbb{D}_e V)$ .

(This cohesive **higher Cartan geometry** is formalized in Modal Homotopy Type Theory:  
[Sc15, §3][Cherubini (né Wellen) 17].)



For  $V \in \text{Grp}(\text{SupSmthGrpd}_\infty)$  a super group stack such as super-Minkowski  $V = \mathbb{R}^{d,1|\mathbb{N}}$ :

**Def.:** A  $V$ -fold is an étale  $\infty$ -stack locally diffeomorphic to  $V \xleftarrow[\text{ét}]{V\text{-atlas}} U \xrightarrow[\text{eff.epi}]{V\text{-fold}} X$ .

**Thm.:** A  $V$ -fold  $X$  naturally has a **frame  $\infty$ -bundle**  $X \xrightarrow{\vdash\text{Fr}(X)} \mathbf{BAut}(\mathbb{D}_e V)$ .

**Def.:** For  $\text{str} : \mathcal{G} \rightarrow \text{Aut}(\mathbb{D}_e V)$  we have moduli of  $\mathcal{G}$ -structures on  $V$ -folds  $X$ :

$$\text{Map}(X, \mathbf{B}\mathcal{G})_{\mathbf{BAut}(\mathbb{D}_e V)} = \left\{ \begin{array}{ccc} X & \overset{\tau}{\dashrightarrow} & \mathbf{B}\mathcal{G} \\ \swarrow \vdash\text{Fr}(X) & \overset{\sim}{\rightleftarrows} \text{vielbein} & \searrow \mathbf{Bstr} \\ & \mathbf{BAut}(\mathbb{D}_e V) & \end{array} \right\}$$

(This cohesive **higher Cartan geometry** is formalized in Modal Homotopy Type Theory: [Sc15, §3][Cherubini (né Wellen) 17].)

For  $V \in \text{Grp}(\text{SupSmthGrpd}_\infty)$  a super group stack such as super-Minkowski  $V = \mathbb{R}^{d,1|\mathbf{N}}$ :

**Def.:** A  $V$ -fold is an étale  $\infty$ -stack locally diffeomorphic to  $V \xleftarrow{\text{ét}} U \xrightarrow{\text{eff.epi}} X$ .

**Thm.:** A  $V$ -fold  $X$  naturally has a **frame  $\infty$ -bundle**  $X \xrightarrow{\vdash \text{Fr}(X)} \mathbf{BAut}(\mathbb{D}_e V)$ .

**Def.:** For  $\text{str} : \mathcal{G} \rightarrow \text{Aut}(\mathbb{D}_e V)$  we have moduli of  $\mathcal{G}$ -structures on  $V$ -folds  $X$ :

$$\text{Map}(X, \mathbf{B}\mathcal{G})_{\mathbf{BAut}(\mathbb{D}_e V)} = \left\{ \begin{array}{ccc} X & \overset{\tau}{\dashrightarrow} & \mathbf{B}\mathcal{G} \\ \swarrow \vdash \text{Fr}(X) & \begin{array}{c} \overset{\sim}{\rightleftarrows} \\ \text{vielbein} \end{array} & \searrow \mathbf{B}\text{str} \\ & \mathbf{BAut}(\mathbb{D}_e V) & \end{array} \right\}$$

**So** for  $X$  a  $\mathbb{R}^{d,1|\mathbf{N}}$ -fold we have moduli of **super-vielbein fields**:

$$\text{Map}(X, \mathbf{BSpin}(d))_{\mathbf{BGL}(d,1|\mathbf{N})} = \left\{ \begin{array}{ccc} X & \overset{\tau}{\dashrightarrow} & \mathbf{BSpin}(d) \\ \swarrow \vdash \text{Fr}(X) & \begin{array}{c} \overset{\sim}{\rightleftarrows} \\ \text{vielbein} \end{array} & \searrow \\ & \mathbf{BGL}(d|\mathbf{N}) & \end{array} \right\}$$

(This cohesive **higher Cartan geometry** is formalized in Modal Homotopy Type Theory: [Sc15, §3][Cherubini (né Wellen) 17].)

# Singular-Cohesive Homotopy Theory of orbi- $\infty$ -stacks.

[Rezk14][SS20-OrbCoh]

Higher geometry locally modeled on orbi-singularities:

$$\text{Snglrt} := \left\{ \underset{\mathcal{Y}}{G} \mid G \text{ fin. group} \right\} \quad \text{with} \quad \text{Map}\left(\underset{\mathcal{Y}}{K}, \underset{\mathcal{Y}}{G}\right) =$$

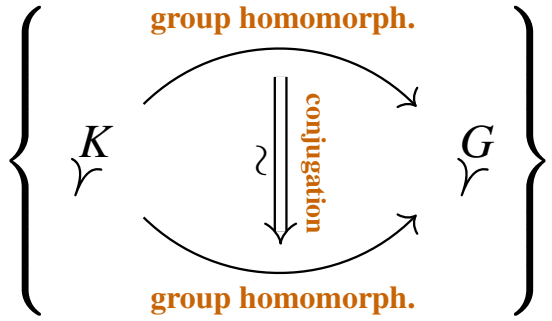

$$\mathbf{H} = \text{GloSupSmthGrpd}_\infty := \text{Sh}_\infty(\text{SupCartSp} \times \text{Snglrt})$$

orbi-singular super- $\infty$ -stacks

faithfully subsumes proper equivariant homotopy theory:

# Singular-Cohesive Homotopy Theory of orbi- $\infty$ -stacks.

[Rezk14][SS20-OrbCoh]

Higher geometry locally modeled on orbi-singularities:

$$\text{Snglrt} := \left\{ \underset{\gamma}{G} \mid G \text{ fin. group} \right\} \quad \text{with} \quad \text{Map}\left(\underset{\gamma}{K}, \underset{\gamma}{G}\right) = \left\{ \begin{array}{ccc} & \text{group homomorph.} & \\ \underset{\gamma}{K} & \begin{array}{c} \curvearrowright \\ \Downarrow \text{conjugation} \\ \curvearrowleft \end{array} & \underset{\gamma}{G} \\ & \text{group homomorph.} & \end{array} \right\}$$

$$\mathbf{H} = \text{GloSupSmthGrpd}_\infty := \text{Sh}_\infty(\text{SupCartSp} \times \text{Snglrt})$$

orbi-singular super- $\infty$ -stacks

faithfully subsumes proper equivariant homotopy theory:

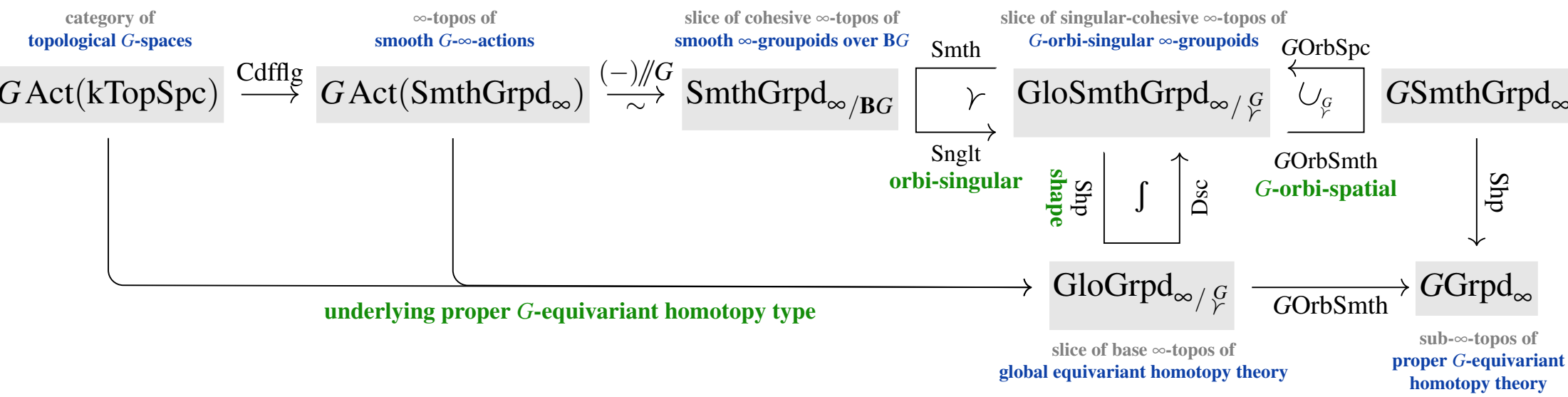

# Singular-Cohesive Homotopy Theory of orbi- $\infty$ -stacks.

[Rezk14][SS20-OrbCoh]

Higher geometry locally modeled on orbi-singularities:

$$\text{Snglrt} := \left\{ \begin{array}{c} G \\ \gamma \end{array} \middle| G \text{ fin. group} \right\} \text{ with } \text{Map} \left( \begin{array}{c} K \\ \gamma \end{array}, \begin{array}{c} G \\ \gamma \end{array} \right) = \left\{ \begin{array}{ccc} & \text{group homomorph.} & \\ \begin{array}{c} K \\ \gamma \end{array} & \begin{array}{c} \curvearrowright \\ \text{conjugation} \\ \curvearrowleft \end{array} & \begin{array}{c} G \\ \gamma \end{array} \\ & \text{group homomorph.} & \end{array} \right\}$$

$$\mathbf{H} = \text{GloSupSmthGrpd}_\infty := \text{Sh}_\infty(\text{SupCartSp} \times \text{Snglrt})$$

orbi-singular super- $\infty$ -stacks

faithfully subsumes proper equivariant homotopy theory:

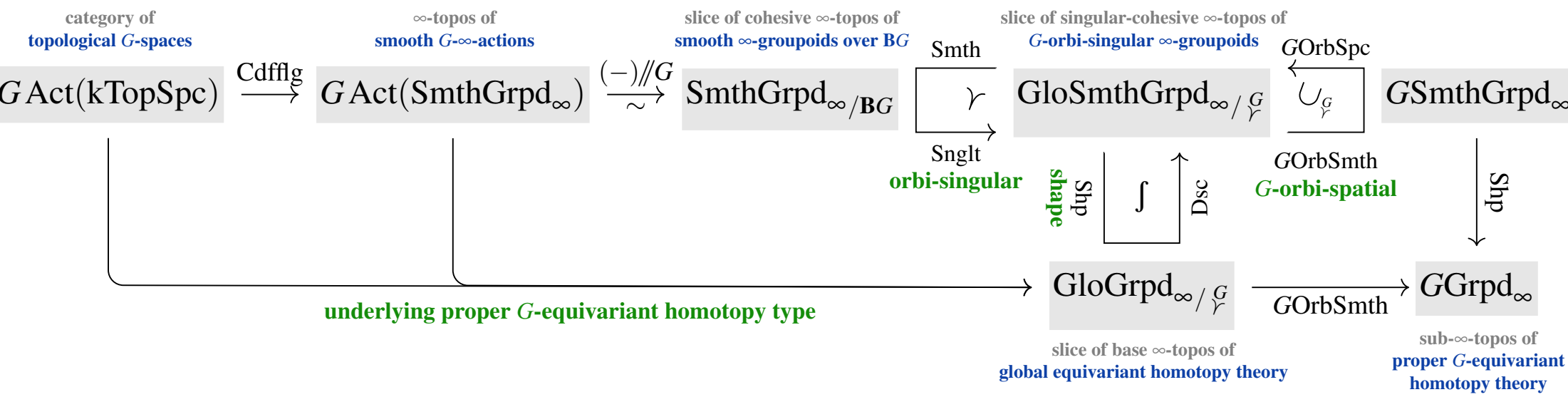

**Thm.** (§4.1 in [SS20-OrbCoh])

Good orbifolds covered by  $G \curvearrowright X$  are equivalently  $\gamma(X//G) \in \mathbf{H} = \text{GloSmthGrpd}_\infty$  and their proper-equivariant homotopy type is:

$$\int \gamma(X//G) \simeq \text{GOrbSpc} \left( \int (X^{(-)}) \right) \in \text{GGrpd}_\infty \xrightarrow{\text{DscGOrbSpc}} \mathbf{H}/\gamma$$

**Theorem.**

If  $G \curvearrowright \Gamma$  is a  $G$ -equivariant Hausdorff-topological group with  $\int \Gamma$  truncated, then

$$\begin{array}{c}
 \text{equivariant} \\
 \text{classifying shape}
 \end{array}
 B_G \Gamma
 :=
 \begin{array}{c}
 \cup_G \\
 \int \\
 \text{shape}
 \end{array}
 \begin{array}{c}
 \text{orbi-spatial} \\
 \text{orbi-singular} \\
 \text{delooping}
 \end{array}
 \mathbf{B} \Gamma
 \in \mathbf{H}.$$

**Theorem.**

If  $G \curvearrowright \Gamma$  is a  $G$ -equivariant Hausdorff-topological group with  $\int \Gamma$  truncated, then

$$\begin{array}{c}
 \text{equivariant} \\
 \text{classifying shape}
 \end{array}
 B_G \Gamma
 :=
 \begin{array}{c}
 \cup_G \\
 \int \\
 \text{shape}
 \end{array}
 \begin{array}{c}
 \text{orbi-spatial} \\
 \text{orbi-singular} \\
 \text{delooping}
 \end{array}
 \Gamma
 \in
 \mathbf{H}.$$

classifies  $G$ -equivariant  $\Gamma$ -principal bundles on  $G$ -orbifolds  $\mathcal{X} \simeq \gamma(X // G) \in \mathbf{H}_{/\gamma}^G$ :

$$(G \text{ Equiv } \Gamma \text{ PrnBdl}_X) / \sim_{\text{iso}} \simeq \tau_0 \text{Map}(\mathcal{X}, B_G \Gamma)_{/\gamma}^G$$

**Theorem.**

If  $G \curvearrowright \Gamma$  is a  $G$ -equivariant Hausdorff-topological group with  $\int \Gamma$  truncated, then

$$B_G \Gamma := \bigcup_G \int \gamma \mathbf{B} \Gamma \in \mathbf{H}.$$

*equivariant classifying shape*      *G-orbi-spatial shape*      *orbi-singular delooping*

classifies  $G$ -equivariant  $\Gamma$ -principal bundles on  $G$ -orbifolds  $\mathcal{X} \simeq \gamma(X // G) \in \mathbf{H}_{/\gamma} G$ :

$$(G \text{Equiv} \Gamma \text{PrnBdl}_X) / \sim_{\text{iso}} \simeq \tau_0 \text{Map}(\mathcal{X}, B_G \Gamma)_{/\gamma} G$$

and its equivariant homotopy groups are given by non-abelian group cohomology:

$$\pi_{\bullet}^H(B_G \Gamma) \simeq H_{\text{Grp}}^{1-\bullet}(H; \int \Gamma)$$

*equivariant homotopy groups*      *equivariant classifying shape*      *non-abelian group cohomology*      *isotropy group*      *shape of structure group*



Specifically, for

$$1 \rightarrow N \hookrightarrow G \twoheadrightarrow \mathbb{Z}_2 \rightarrow 1$$

and

$$\mathbb{Z}_2 \curvearrowright \mathrm{PU}_\omega^{\mathrm{gr}} \in G\mathrm{Act}(\mathrm{Grp}(\mathrm{kTopSpc}))$$

the graded projective unitary group acted on by complex conjugation, the  $G$ -orbi-space

$$B_G(\mathrm{PU}_\omega^{\mathrm{gr}}) \in \mathbf{H}$$

classifies type **IIA**  $B$ -fields on  $G$ -orbi-orientifolds

$$\left\{ \begin{array}{l} \text{type IIA } B_2\text{-fields on} \\ G\text{-orbi-orientifold } \mathcal{X} \end{array} \right\}_{\sim_{\text{gauge}}} \simeq \tau_0 \mathrm{Map} \left( \mathcal{X}, B_G(\mathrm{PU}_\omega^{\mathrm{gr}}) \right)_{\mathcal{Y}^G}.$$

with  $\pi_n^H \left( B_G(\mathrm{PU}_\omega) \right) \simeq H_{\mathrm{Grp}}^{3-n}(H; \mathbb{Z})$ , reproducing [UrLü14, Thm. 15.17].

---

Specifically, for

$$1 \rightarrow N \hookrightarrow G \twoheadrightarrow \mathbb{Z}_2 \rightarrow 1$$

and

$$\mathbb{Z}_2 \curvearrowright \mathrm{PU}_\omega^{\mathrm{gr}} \in G\mathrm{Act}(\mathrm{Grp}(\mathbf{kTopSpc}))$$

the graded projective unitary group acted on by complex conjugation, the  $G$ -orbi-space

$$B_G(\mathrm{PU}_\omega^{\mathrm{gr}}) \in \mathbf{H}$$

classifies type **IIA**  $B$ -fields on  $G$ -orbi-orientifolds

$$\left\{ \begin{array}{l} \text{type IIA } B_2\text{-fields on} \\ G\text{-orbi-orientifold } \mathcal{X} \end{array} \right\}_{\sim_{\text{gauge}}} \simeq \tau_0 \mathrm{Map} \left( \mathcal{X}, B_G(\mathrm{PU}_\omega^{\mathrm{gr}}) \right)_G.$$

with  $\pi_n^H \left( B_G(\mathrm{PU}_\omega) \right) \simeq H_{\mathrm{Grp}}^{3-n}(H; \mathbb{Z})$ , reproducing [UrLü14, Thm. 15.17].

**Philosophical question:**

But *why* coefficients like  $B_G \mathrm{PU}_\omega$ ? *Are there god-given coefficients?*



For any line object  $\mathbb{A}^1$  there are the *Tate spheres* (e.g. [VRO07, Rem. 2.22])

$$S_{\text{Tate}}^n := \text{cof}(\mathbb{A}^n \setminus \{0\} \hookrightarrow \mathbb{A}^n) \in \mathbf{H}$$

---

For any line object  $\mathbb{A}^1$  there are the *Tate spheres* (e.g. [VRO07, Rem. 2.22])

$$S_{\text{Tate}}^n := \text{cof}(\mathbb{A}^n \setminus \{0\} \hookrightarrow \mathbb{A}^n) \in \mathbf{H}$$

---

Specifically for  $\mathbb{A}^1 := \mathbb{R}^1 \in \text{SmthGrpd}_\infty$  (incidentally  $\int \simeq \text{Loc}^{\mathbb{R}^1} : \mathbf{H} \rightarrow \mathbf{H}$ )  
we have the **smooth Tate spheres**

$$S_{\text{Tate}}^n := \text{cof}(\mathbb{R}^n \setminus \{0\} \hookrightarrow \mathbb{R}^n) \in \mathbf{H}.$$

Their shape is that of the ordinary  $n$ -spheres ([SS20-OrbCoh, Ex. 5.21]):

$$\int S_{\text{Tate}}^n \simeq S^n \in \text{Grpd}_\infty \xrightarrow{\text{Dsc}} \mathbf{H}$$

---

For any line object  $\mathbb{A}^1$  there are the *Tate spheres* (e.g. [VRO07, Rem. 2.22])

$$S_{\text{Tate}}^n := \text{cof}(\mathbb{A}^n \setminus \{0\} \hookrightarrow \mathbb{A}^n) \in \mathbf{H}$$

Specifically for  $\mathbb{A}^1 := \mathbb{R}^1 \in \text{SmthGrpd}_\infty$  (incidentally  $\int \simeq \text{Loc}^{\mathbb{R}^1} : \mathbf{H} \rightarrow \mathbf{H}$ )  
we have the **smooth Tate spheres**

$$S_{\text{Tate}}^n := \text{cof}(\mathbb{R}^n \setminus \{0\} \hookrightarrow \mathbb{R}^n) \in \mathbf{H}.$$

Their shape is that of the ordinary  $n$ -spheres ([SS20-OrbCoh, Ex. 5.21]):

$$\int S_{\text{Tate}}^n \simeq S^n \in \text{Grpd}_\infty \xrightarrow{\text{Dsc}} \mathbf{H}$$

More generally, for any

$$G \curvearrowright V \in G\text{Act}(\text{VectorSpaces}_\mathbb{R}) \hookrightarrow G\text{Act}(\text{SmthMfd}) \hookrightarrow G\text{Act}(\mathbf{H})$$

we have the **orbi-smooth  $V$ -Tate spheres** ([SS20-OrbCoh, Ex. 5.27])

$$\int \gamma(S_{\text{Tate}}^V // G) \in \mathbf{H}_{/\gamma}^G.$$

---

The  $G_{\text{ADE}}$ -equivariant Tate 4-sphere has equivariant homotopy type of the 4-representation sphere:

$$\int \mathcal{Y}(S_{\text{Tate}}^4 // G_{\text{ADE}}) \underset{\substack{\text{stereogr.} \\ \text{project.}}}{\cong} S(\mathbb{R} \oplus \overset{G_{\text{ADE}}}{\mathbb{H}}) \in G_{\text{ADE}} \text{Grpd}_{\infty} \xrightarrow{\text{Dsc } G_{\text{ADE}} \text{ OrbSpc}} \mathbf{H} / \mathcal{Y}_{G_{\text{ADE}}}$$

**Example: The ADE-equivariant 4-sphere.**

§5.1 in [HSS18-ADE]; §3 in [SS19-TadCnc]

Consider the left multiplication action of  $\mathrm{Sp}(1) = S(\mathbb{H})$  on the quaternions  $\mathbb{H}$ :

$$\mathrm{Sp}(1) \curvearrowright \mathbb{H} \simeq \mathrm{SU}(2)_L \curvearrowright \mathbb{C}^2 \simeq \mathrm{Spin}(3)_L \curvearrowright \mathbb{R}^4.$$

The finite subgroups have a famous ADE-classification:

Label	$G_{\mathrm{ADE}} \subset_{\mathrm{fin}} \mathrm{SU}(2)$	Order	Name
$\mathbb{A}_n$	$\mathbb{Z}_{n+1}$	$n$	Cyclic
$\mathbb{D}_{n+4}$	$2\mathbb{D}_{n+2}$	$4(n+2)$	Binary dihedral
$\mathbb{E}_6$	$2\mathbb{T}$	24	Binary tetrahedral
$\mathbb{E}_7$	$2\mathbb{O}$	48	Binary octahedral
$\mathbb{E}_8$	$2\mathbb{I}$	120	Binary icosahedral

Denote the restricted representation by  $\mathbf{4} := G_{\mathrm{ADE}} \curvearrowright \mathbb{R}^4 \in \mathrm{RO}(G_{\mathrm{ADE}})$ .

The  $G_{\mathrm{ADE}}$ -equivariant Tate  $\mathbf{4}$ -sphere has equivariant homotopy type of the  $\mathbf{4}$ -representation sphere:

$$\int \gamma(S_{\mathrm{Tate}}^{\mathbf{4}} // G_{\mathrm{ADE}}) \underset{\substack{\text{stereogr.} \\ \text{project.}}}{\simeq} S(\mathbb{R} \oplus \overset{G_{\mathrm{ADE}}}{\mathbb{H}}) \in G_{\mathrm{ADE}} \mathrm{Grpd}_{\infty} \xrightarrow{\mathrm{Dsc } G_{\mathrm{ADE}} \mathrm{OrbSpc}} \mathbf{H} / G_{\mathrm{ADE}}$$

**Example: Super-Minkowski orbifolds.**

Thm. 4.3 in [HSS18-ADE]

**Theorem.** Classification of subgroup actions of  $\text{Pin}^+(10, 1) \curvearrowright \mathbb{R}^{10,1|32}$  which fix  $\geq 1/4$ th of **32** such that all non-trivial subgroups have the same bosonic fixed locus:

Black brane species	BPS	Fixed locus in $\mathbb{R}^{10,1 32}$	Type of singularity in $\mathbb{R}^{10,1}$	Intersection law
				$\simeq \mathbb{R}^{1,1} \oplus \mathbb{R}^4 \oplus \mathbb{R}^4 \oplus \mathbb{R}^1$

**Elementary brane species**

**Simple singularities**

MO9	1/2	$\mathbb{R}^{9,1 16}$	$\mathbb{Z}_2$	$=$	—				$(\mathbb{Z}_2)_{\text{HW}}$
MO5	1/2	$\mathbb{R}^{5,1 2 \cdot 8}$	$\mathbb{Z}_2$	$\overset{\Delta}{\subset}$	—				$(\mathbb{Z}_2)_R \times (\mathbb{Z}_2)_{\text{HW}}$
MO1	1/2	$\mathbb{R}^{1,1 16 \cdot 1}$	$\mathbb{Z}_2$	$\overset{\Delta}{\subset}$	—	$(\mathbb{Z}_2)_L$	$\times$	$(\mathbb{Z}_2)_R$	$\times (\mathbb{Z}_2)_{\text{HW}}$
MK6	1/2	$\mathbb{R}^{6,1 16}$	$\mathbb{Z}_{n+1}, 2\mathbb{D}_{n+2}, 2T, 2O, 2I$	$\subset$	—			$\text{SU}(2)_R$	—
M2	1/2 = 8/16	$\mathbb{R}^{2,1 8 \cdot 2}$	$\mathbb{Z}_2$	$\overset{\Delta}{\subset}$	—	$\text{SU}(2)_L$	$\times$	$\text{SU}(2)_R$	—
M2	6/16	$\mathbb{R}^{2,1 6 \cdot 2}$	$\mathbb{Z}_{n+3}$	$\overset{\Delta}{\subset}$	—	$\text{SU}(2)_L$	$\times$	$\text{SU}(2)_R$	—
M2	5/16	$\mathbb{R}^{2,1 5 \cdot 2}$	$2\mathbb{D}_{n+2}, 2T, 2O, 2I$	$\overset{\Delta}{\subset}$	—	$\text{SU}(2)_L$	$\times$	$\text{SU}(2)_R$	—
M2	1/4 = 4/16	$\mathbb{R}^{2,1 4 \cdot 2}$	$2\mathbb{D}_{n+2}, 2O, 2I$	$\overset{(\text{id}, \tau)}{\subset}$	—	$\text{SU}(2)_L$	$\times$	$\text{SU}(2)_R$	—

$$\mathbb{R}^{10,1} \simeq_{\mathbb{R}} \mathbb{R}^{1,1} \oplus \mathbb{R}^4 \oplus \mathbb{R}^4 \oplus \mathbb{R}$$

$\text{SU}(2)_L$        $\text{SU}(2)_R$        $(\mathbb{Z}_2)_{\text{HW}}$



**Example: Super-Minkowski orbifolds.**

Thm. 4.3 in [HSS18-ADE]

**Theorem.** Classification of subgroup actions of  $\text{Pin}^+(10, 1) \curvearrowright \mathbb{R}^{10,1|32}$  which fix  $\geq 1/4$ th of **32** such that all non-trivial subgroups have the same bosonic fixed locus:

Black brane species	BPS	Fixed locus in $\mathbb{R}^{10,1 32}$	Type of singularity in $\mathbb{R}^{10,1}$	Intersection law
				$\simeq \mathbb{R}^{1,1} \oplus \mathbb{R}^4 \oplus \mathbb{R}^4 \oplus \mathbb{R}^1$

**Elementary brane species**

**Simple singularities**

MO9	1/2	$\mathbb{R}^{9,1 16}$	$\mathbb{Z}_2$	=	—				$(\mathbb{Z}_2)_{\text{HW}}$
MO5	1/2	$\mathbb{R}^{5,1 2 \cdot 8}$	$\mathbb{Z}_2$	$\Delta$ $\subset$	—				$(\mathbb{Z}_2)_R \times (\mathbb{Z}_2)_{\text{HW}}$
MO1	1/2	$\mathbb{R}^{1,1 16 \cdot 1}$	$\mathbb{Z}_2$	$\Delta$ $\subset$	—	$(\mathbb{Z}_2)_L$	$\times$	$(\mathbb{Z}_2)_R$	$\times (\mathbb{Z}_2)_{\text{HW}}$
MK6	1/2	$\mathbb{R}^{6,1 16}$	$\mathbb{Z}_{n+1}, 2\mathbb{D}_{n+2}, 2T, 2O, 2I$	$\subset$	—			$\text{SU}(2)_R$	—
M2	1/2 = 8/16	$\mathbb{R}^{2,1 8 \cdot 2}$	$\mathbb{Z}_2$	$\Delta$ $\subset$	—	$\text{SU}(2)_L$	$\times$	$\text{SU}(2)_R$	—
M2	6/16	$\mathbb{R}^{2,1 6 \cdot 2}$	$\mathbb{Z}_{n+3}$	$\Delta$ $\subset$	—	$\text{SU}(2)_L$	$\times$	$\text{SU}(2)_R$	—
M2	5/16	$\mathbb{R}^{2,1 5 \cdot 2}$	$2\mathbb{D}_{n+2}, 2T, 2O, 2I$	$\Delta$ $\subset$	—	$\text{SU}(2)_L$	$\times$	$\text{SU}(2)_R$	—
M2	1/4 = 4/16	$\mathbb{R}^{2,1 4 \cdot 2}$	$2\mathbb{D}_{n+2}, 2O, 2I$	$(\text{id}, \tau)$ $\subset$	—	$\text{SU}(2)_L$	$\times$	$\text{SU}(2)_R$	—

$$\mathbb{R}^{10,1} \simeq_{\mathbb{R}} \mathbb{R}^{1,1} \oplus \overset{\text{SU}(2)_L}{\curvearrowright} \mathbb{R}^4 \oplus \overset{\text{SU}(2)_R}{\curvearrowright} \mathbb{R}^4 \oplus \overset{(\mathbb{Z}_2)_{\text{HW}}}{\curvearrowright} \mathbb{R}$$

**yields super-Minkowski orbifolds, e.g.:**

$$\mathcal{X}_{\text{MK6} \perp \text{K3}} = \mathbb{R}^{6,1|16} \times \gamma(\mathbb{T}^4 // \mathbb{Z}_2^A) \in \mathbf{H}_{\mathbb{Z}_2^A}$$

# J-twisted proper orbifold Cohomotopy.

Def. 5.28 in [SS20-OrbCoh]

Let  $\mathcal{X}$  be an  $\mathbb{R}^{d,1|\mathbf{N}}$ -orbifold

with  $\text{Spin}(n)$ -structure

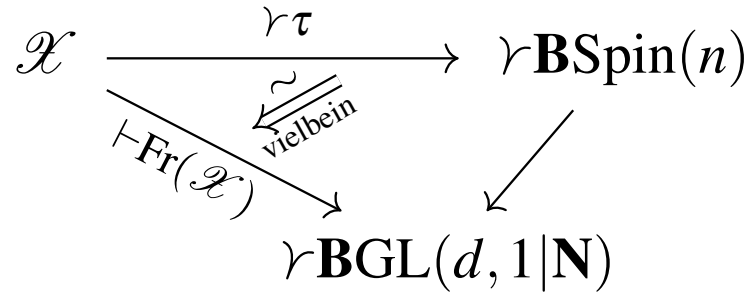

**Def.** ([SS20-OrbCoh, Ex. 5.29]) **J-twisted proper orbifold Cohomotopy** of  $(\mathcal{X}, \tau)$  is :

tangentially J-twisted proper orbifold Cohomotopy
proper equivariant homotopy type of canonical n-sphere

$$\pi^{\int \gamma\tau}(\mathcal{X}) := \pi_0 \text{Map} \left( \mathcal{X}, \int \gamma(S_{\text{Tate}}^n // \text{Spin}(n)) \right)_{\int \gamma\mathbf{BSpin}(d)}$$

proper equivariant tangential twist

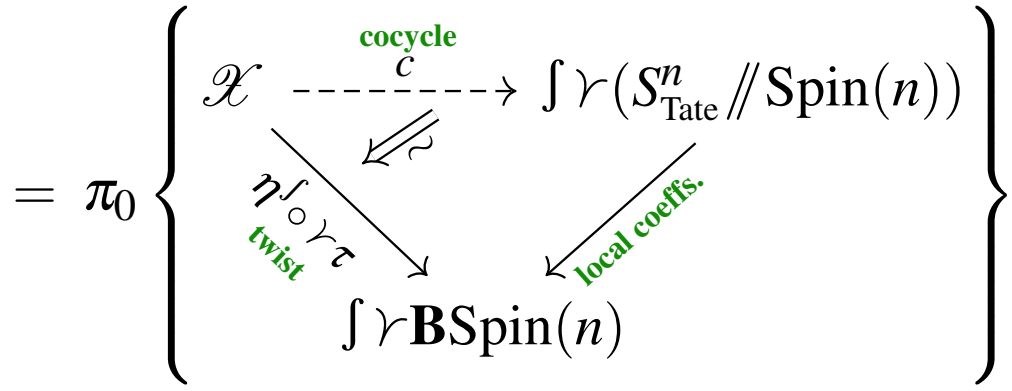

Let  $\mathcal{X}$  be an  $\mathbb{R}^{d,1|\mathbf{N}}$ -orbifold

with  $\text{Spin}(n)$ -structure

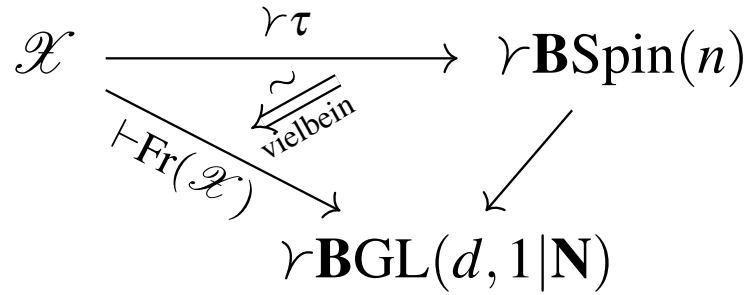

**Def.** ([SS20-OrbCoh, Ex. 5.29]) **J-twisted proper orbifold Cohomotopy** of  $(\mathcal{X}, \tau)$  is :

$$\pi^{\int \gamma\tau}(\mathcal{X}) := \pi_0 \text{Map} \left( \mathcal{X}, \overbrace{\int \gamma(S_{\text{Tate}}^n // \text{Spin}(n))}^{\text{proper equivariant homotopy type of canonical n-sphere}} \right)_{\int \gamma\mathbf{BSpin}(d)}$$

proper equivariant tangential twist

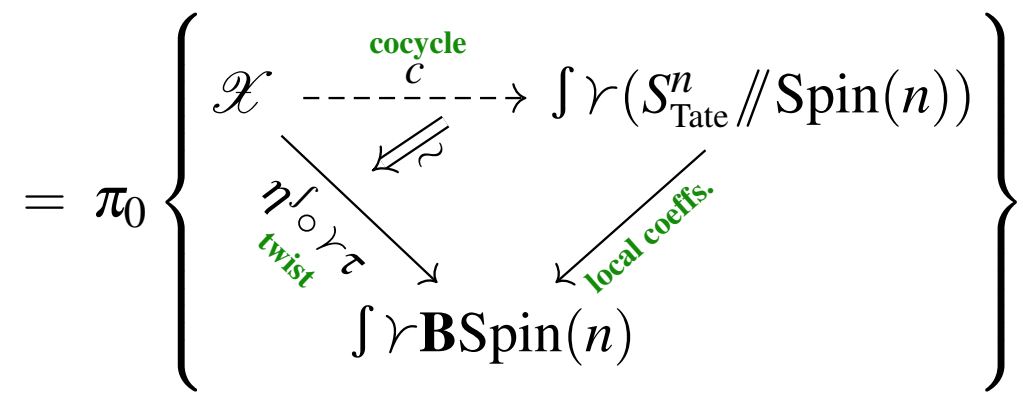

In the case that  $\mathcal{X} = X$  is smooth (i.e. a manifold), this reduces to **J-twisted Cohomotopy**:  
 [FSS19-HypH, Def. 2.1][FSS20-Char, Ex. 2.41], see also [Cru03, Lem. 5.2].

$$\begin{array}{ccc}
 \mathcal{X} & \xrightarrow{\text{cocycle}} & \int \gamma (S_{\text{Tate}}^{\mathbf{n}|N} // \text{Spin}(n)) \\
 \searrow \eta \circ \gamma_\tau & \Downarrow \cong & \downarrow \\
 & & \int \gamma \mathbf{B}\text{Spin}(n)
 \end{array}$$

**Key Structure Theorem:**

In limiting cases this reduces to:

- (a) equiv Cohomotopy in RO-deg  $\mathbf{n}$
- (b) tangent J-twisted Cohomotopy

tangentially J-twisted orbifold Cohomotopy

$$\pi^{\int \gamma_\tau}(\mathcal{X})$$

(a) on flat orbifolds

$$\mathcal{X} = \gamma(\mathbb{T}^d // G)$$

(b) on smooth orbifolds

$$\mathcal{X} = X$$

- [HSS18-ADE]
- [SS19-TadCnc]
- [BSS19-FrcBrn]
- [SS20-M5GS]

$$\pi_G^{\mathbf{n}}(\mathbb{T}^d)$$

equivariant Cohomotopy in RO-degree  $\mathbf{n}$

- [FSS19-HypH]
- [FSS19-M5WZ]
- [FSS20-M5Str]
- [SS20-M5Anom]
- [FSS20-GSAnom]

$$\pi^\tau(X)$$

tangentially J-twisted Cohomotopy

$$\begin{array}{ccc}
 \gamma(\mathbb{T}^d // G) & \xrightarrow{\text{cocycle}} & \int \gamma (S^n // G) \\
 \searrow \gamma_\tau & \Downarrow \cong & \downarrow \\
 & & \gamma G
 \end{array}$$

$$\begin{array}{ccc}
 X & \xrightarrow{\text{cocycle}} & S^n // \text{Spin}(n) \\
 \searrow \int_\tau & \Downarrow \cong & \downarrow \\
 & & \mathbf{B}\text{Spin}(n)
 \end{array}$$

higher orbi-geometry

orbifold cohomology

I – Proper Orbifold Cohomology

II – **for M-Theory**

Hypothesis H

M5-brane charges in  
flat orbi-orientifolds

*Future historians may judge the late 20th century as a time when theorists were like children playing on the seashore, diverting themselves with the smoother pebbles or prettier shells of superstrings while the great ocean of M-theory lay undiscovered before them.*

M. Duff (1998)

closing sentence in:

M. Duff:

*The Theory Formerly Known as Strings*

Scient Amer 1998

Non-perturbative completion of a theory of charged objects  
with flux densities satisfying Bianchi identities  
involves choosing a non-abelian cohomology theory  $A$   
whose character image enforces these Bianchi identities:

Non-perturbative completion of a theory of charged objects with flux densities satisfying Bianchi identities involves choosing a non-abelian cohomology theory  $A$  whose character image enforces these Bianchi identities:

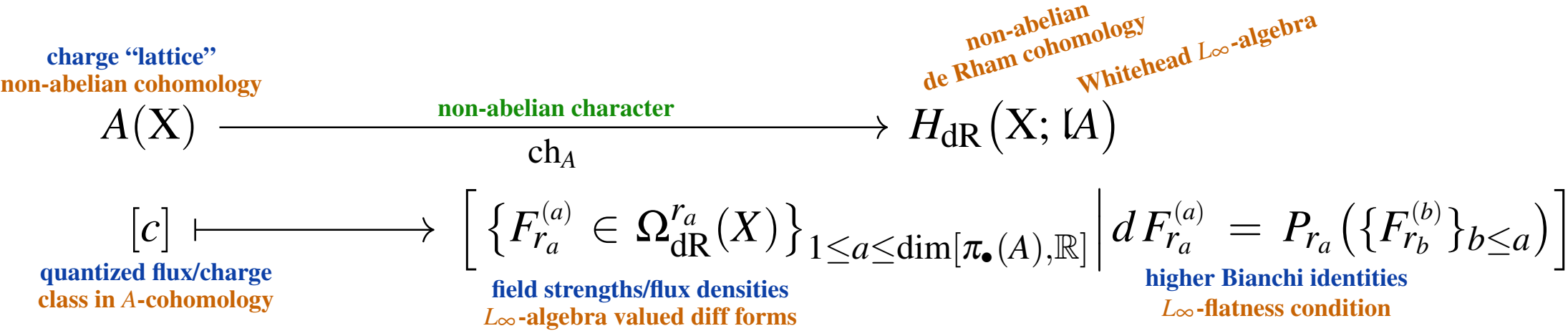



Non-perturbative completion of a theory of charged objects with flux densities satisfying Bianchi identities involves choosing a non-abelian cohomology theory  $A$  whose character image enforces these Bianchi identities:

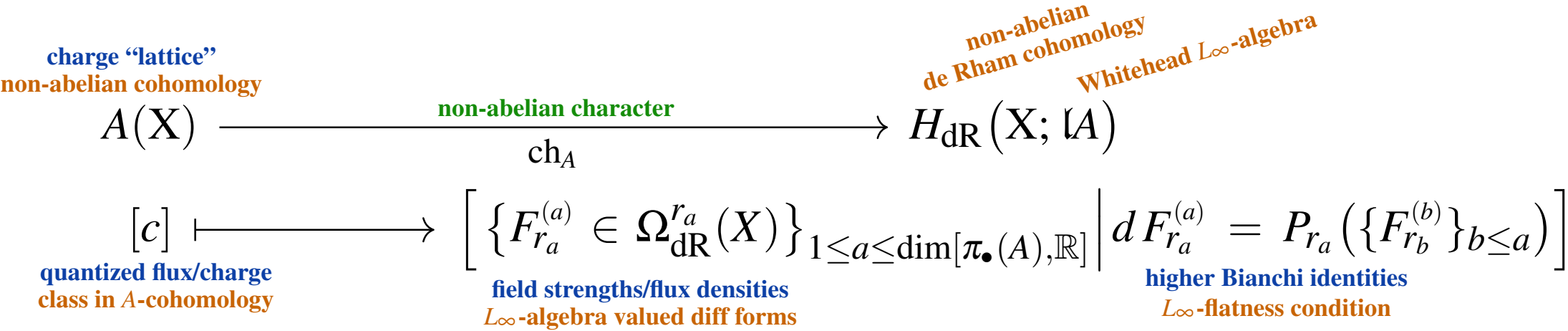

The choice of  $A$  is a **hypothesis** about the correct non-perturbative completion.

Non-perturbative completion of a theory of charged objects with flux densities satisfying Bianchi identities involves choosing a non-abelian cohomology theory  $A$  whose character image enforces these Bianchi identities:

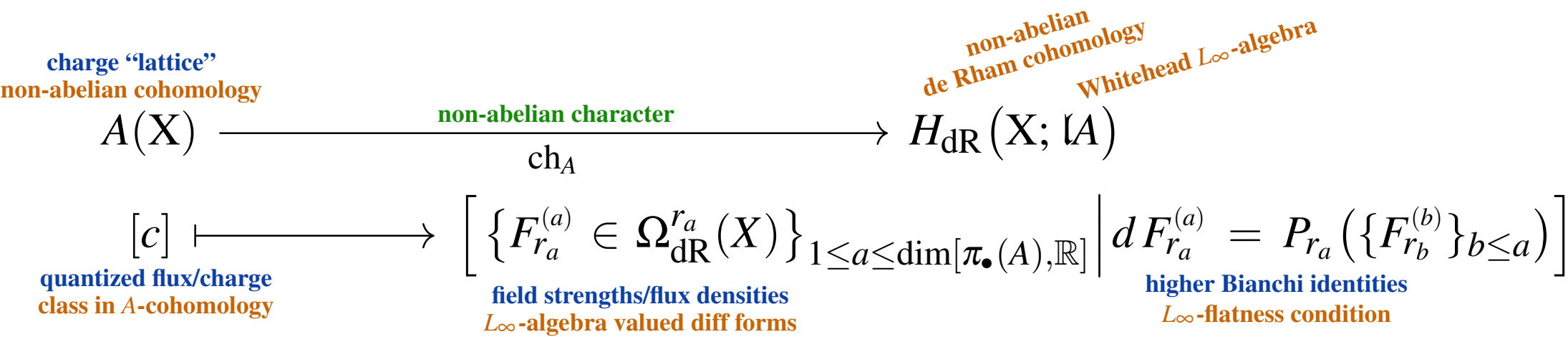

The choice of  $A$  is a **hypothesis** about the correct non-perturbative completion.

Given such a choice, the moduli  $\infty$ -stack of fields is a differential refinement of  $A$ :

$$\mathcal{A} = \widehat{A} \in \text{SmthGrpd}_\infty$$

**Fact:** The Bianchi identity of the **type IIA RR/B-fields**

is that enforced by the Whitehead  $L_\infty$ -algebra of twisted KU-theory

$$H_{\text{dR}}(X, \mathfrak{l}(\text{KU} // \text{BU}(1))) \simeq \left\{ \left( \begin{array}{c} \{F_{2k}\}_k \\ H_3 \end{array} \right) \in \Omega_{\text{dR}}^\bullet(X) \mid \begin{array}{l} dF_{2k} = H_3 \wedge F_{2k-2} \\ dH_3 = 0 \end{array} \right\} \sim_{\text{conc}}$$

The evident **hypothesis** here is the proposal by Minasian/Moore/Witten/Bouwknegt/Mathai:

*The type IIA RR/B-field is flux-quantized in twisted K-theory.*

It *must* be flux-quantized in something at least close, such as orbifold KR-theory.

---

## Hypothesis H.

[Sa13, §2.5][FSS16-RatCoh][FSS19-HypH][SS21-MF]

**Fact:** The Bianchi identity of the **type IIA RR/B-fields**

is that enforced by the Whitehead  $L_\infty$ -algebra of twisted KU-theory

$$H_{\text{dR}}(\mathbf{X}, \mathfrak{l}(\text{KU} // \text{BU}(1))) \simeq \left\{ \left( \begin{array}{c} \{F_{2k}\}_k \\ H_3 \end{array} \right) \in \Omega_{\text{dR}}^\bullet(\mathbf{X}) \left| \begin{array}{l} dF_{2k} = H_3 \wedge F_{2k-2} \\ dH_3 = 0 \end{array} \right. \right\} \sim_{\text{conc}}$$

The evident **hypothesis** here is the proposal by Minasian/Moore/Witten/Bouwknegt/Mathai:

*The type IIA RR/B-field is flux-quantized in twisted K-theory.*

It *must* be flux-quantized in something at least close, such as orbifold KR-theory.

---

**Fact:** The Bianchi identity of the **M-theory C-field** is

that enforced by the Whitehead  $L_\infty$ -algebra of 4-Cohomotopy:

$$H_{\text{dR}}(\mathbf{X}, \mathfrak{l}S^4) \simeq \left\{ \left( \begin{array}{c} G_7 \\ G_4 \end{array} \right) \in \Omega_{\text{dR}}^\bullet(\mathbf{X}) \left| \begin{array}{l} dG_7 = -\frac{1}{2}G_4 \wedge G_4 \\ dG_4 = 0 \end{array} \right. \right\} \sim_{\text{conc}}$$

The evident **hypothesis** here [Sa13, §2.5] we called Hypothesis H:

*The M-theory C-field is flux-quantized in 4-Cohomotopy.*

It *must* be charge-quantized in something at least close, such as J-twisted orbifold Cohomotopy.

# Approximating Cohomotopy by K-theory.

[BSS19-FrcBrn][SS19-TadCnc][SS21-MF]

J-twisted orbifold Cohomotopy  
around an orbi-singularity

$$\pi_G^4(\mathbb{R}_{\text{cpt}}^4)$$

un-stable/  
non-linear!

equivariant generalized  
cohomologies in RO-degree 4

equivariant generalized  
cohomologies of the point

representation  
rings

# Approximating Cohomotopy by K-theory.

[BSS19-FrcBrn][SS19-TadCnc][SS21-MF]

**J-twisted orbifold Cohomotopy  
around an orbi-singularity**

$$\pi_G^4(\mathbb{R}_{\text{cpt}}^4)$$

**un-stable/  
non-linear!**

**stabilization/  
linearization**

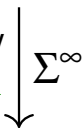

**equivariant  
stable Cohomotopy**

$$\mathbb{S}_G^4(S^4) \quad \text{=====} \quad \mathbb{S}_G^0$$

**equivariant generalized  
cohomologies in RO-degree 4**

**equivariant generalized  
cohomologies of the point**

**representation  
rings**

# Approximating Cohomotopy by K-theory.

[BSS19-FrcBrn][SS19-TadCnc][SS21-MF]

J-twisted orbifold Cohomotopy  
around an orbi-singularity

$$\pi_G^4(\mathbb{R}_{\text{cpt}}^4)$$

un-stable/  
non-linear!

stabilization/  
linearization  $\downarrow \Sigma^\infty$

equivariant  
stable Cohomotopy

$$\mathbb{S}_G^4(S^4)$$

$$\equiv$$

$$\mathbb{S}_G^0$$

$$\xrightarrow[\text{[De06][Gui06]}]{\text{[BP72][Se74]}}$$

$$\mathbf{R}_{\mathbb{F}_1}(G)$$

$$\xrightarrow{\text{[Se71][tD79]}}$$

$$A_G$$

Burnside  
ring

equivariant generalized  
cohomologies in RO-degree 4

equivariant generalized  
cohomologies of the point

representation  
rings

# Approximating Cohomotopy by K-theory.

[BSS19-FrcBrn][SS19-TadCnc][SS21-MF]

J-twisted orbifold Cohomotopy  
around an orbi-singularity

$$\pi_G^4(\mathbb{R}_{\text{cpt}}^4)$$

un-stable/  
non-linear!

stabilization/  
linearization  
 $\downarrow \Sigma^\infty$

equivariant  
stable Cohomotopy

$$\mathbb{S}_G^4(S^4)$$

$$\equiv \mathbb{S}_G^0$$

$$\mathbb{S}_G^0$$

$\xrightarrow{[\text{BP72}][\text{Se74}]}$   
 $\xrightarrow{[\text{De06}][\text{Gui06}]}$

$$\mathbb{R}_{\mathbb{F}_1}(G)$$

$\xrightarrow{[\text{Se71}][\text{tD79}]}$

$$A_G$$

Burnside  
ring

Hurewicz-Boardman  
homomorphism  
(initiality of S)

$\downarrow$

$\downarrow \beta$

$\downarrow \otimes_{\mathbb{F}_1} \mathbb{R}$

equivariant  
orth. K-theory

$$\text{KO}_G^4(S^4)$$

$$\equiv \text{KO}_G^0$$

$$\equiv \text{KO}_G^0$$

$$\equiv \mathbb{R}_{\mathbb{R}}(G)$$

$$\mathbb{R}_{\mathbb{R}}(G)$$

equivariant generalized  
cohomologies in RO-degree 4

equivariant generalized  
cohomologies of the point

representation  
rings



# Approximating Cohomotopy by K-theory.

[BSS19-FrcBrn][SS19-TadCnc][SS21-MF]

J-twisted orbifold Cohomotopy  
around an orbi-singularity

$$\pi_G^4(\mathbb{R}_{\text{cpt}}^4)$$

un-stable/  
non-linear!

stabilization/  
linearization  $\Sigma^\infty$

equivariant  
stable Cohomotopy

$$\mathbb{S}_G^4(S^4)$$

$$\equiv \mathbb{S}_G^0$$

$$\xrightarrow[\text{[De06][Gui06]}]{\text{[BP72][Se74]}} \mathbb{R}_{\mathbb{F}_1}(G)$$

$$\xrightarrow{\text{[Se71][tD79]}} A_G$$

Burnside  
ring

equivariant  
orth. K-theory

$$\text{KO}_G^4(S^4)$$

Hurewicz-Boardman  
homomorphism  
(initiality of S)

$$\downarrow \beta$$

$$\text{KO}_G^0$$

$$\equiv \mathbb{R}_{\mathbb{R}}(G)$$

$$\downarrow \otimes_{\mathbb{F}_1} \mathbb{R}$$

further  
extension of scalars

$$\downarrow \otimes_{\mathbb{R}} \mathbb{C}$$

$$\text{KU}_G^0$$

$$\equiv \mathbb{R}_{\mathbb{C}}(G)$$

$$\downarrow \otimes_{\mathbb{R}} \mathbb{C}$$

equivariant  
complex K-theory

$$\text{KU}_G^4(S^4)$$

equivariant generalized  
cohomologies in RO-degree 4

equivariant generalized  
cohomologies of the point

representation  
rings

# Approximating Cohomotopy by K-theory.

[BSS19-FrcBrn][SS19-TadCnc][SS21-MF]

J-twisted orbifold Cohomotopy  
around an orbi-singularity

$$\pi_G^4(\mathbb{R}_{\text{cpt}}^4)$$

un-stable/  
non-linear!

stabilization/  
linearization  
 $\Sigma^\infty$

equivariant  
stable Cohomotopy

$$\mathbb{S}_G^4(S^4)$$

$$\equiv \mathbb{S}_G^0$$

$$\xrightarrow[\text{[De06][Gui06]}]{\text{[BP72][Se74]}}$$

$$\mathbb{R}_{\mathbb{F}_1}(G)$$

$$\xrightarrow{\text{[Se71][tD79]}}$$

$$A_G$$

Burnside  
ring

Hurewicz-Boardman  
homomorphism  
(initiality of S)

$\beta$

equivariant  
orth. K-theory

$$\text{KO}_G^4(S^4)$$

$$\equiv \text{KO}_G^0$$

$$\equiv \mathbb{R}(G)$$

$\otimes_{\mathbb{F}_1} \mathbb{R}$

equivariant  
complex K-theory

$$\text{KU}_G^4(S^4)$$

further  
extension of scalars

$\otimes_{\mathbb{R}} \mathbb{C}$

$$\equiv \text{KU}_G^0$$

$$\equiv \mathbb{R}(G)$$

$\otimes_{\mathbb{R}} \mathbb{C}$

equivariant generalized  
cohomologies in RO-degree 4

equivariant generalized  
cohomologies of the point

representation  
rings

linearize virtual G-sets of fractional M-branes  
to virtual G-representations of fractional D-branes

J-twisted orbifold Cohomotopy  
around an orbi-singularity

$$\pi_G^4(\mathbb{R}_{\text{cpt}}^4)$$

un-stable/  
non-linear!

stabilization/  
linearization  
 $\Sigma^\infty$

equivariant  
stable Cohomotopy

$$\mathbb{S}_G^4(S^4)$$

$$\equiv \mathbb{S}_G^0$$

$$\xrightarrow[\text{[De06][Gui06]}]{\text{[BP72][Se74]}}$$

$$\mathbb{R}_{\mathbb{F}_1}(G)$$

$$\xrightarrow[\text{[Se71][tD79]}]{\text{[Se71][tD79]}}$$

$$A_G$$

Burnside  
ring

Hurewicz-Boardman  
homomorphism  
(initiality of S)

$\beta$

$\otimes_{\mathbb{F}_1} \mathbb{R}$

equivariant  
orth. K-theory

$$\text{KO}_G^4(S^4)$$

$$\equiv \text{KO}_G^0$$

$$\equiv \mathbb{R}_{\mathbb{R}}(G)$$

$$\equiv \mathbb{R}_{\mathbb{R}}(G)$$

$$\equiv \mathbb{R}_{\mathbb{R}}(G)$$

further  
extension of scalars

$\otimes_{\mathbb{R}} \mathbb{C}$

$\otimes_{\mathbb{R}} \mathbb{C}$

equivariant  
complex K-theory

$$\text{KU}_G^4(S^4)$$

$$\equiv \text{KU}_G^0$$

$$\equiv \mathbb{R}_{\mathbb{C}}(G)$$

$$\equiv \mathbb{R}_{\mathbb{C}}(G)$$

$$\equiv \mathbb{R}_{\mathbb{C}}(G)$$

linearize virtual G-sets of fractional M-branes  
to virtual G-representations of fractional D-branes

equivariant generalized  
cohomologies in RO-degree 4

equivariant generalized  
cohomologies of the point

representation  
rings

**Rem.** [FSS20-Char, (353)].

The Boardman homomorphism exhibits exactly the identification  $G_4 \mapsto F_4$  of [DMW00]:

$$\begin{array}{ccccccc}
 \text{ch} \left\{ \begin{array}{l} \xrightarrow{\pi^4} \\ \xrightarrow{(G_4, G_7)} \end{array} \right. & \xrightarrow[\text{stabilization / linearization}]{\Sigma^\infty} & S^4 & \xrightarrow[\text{Boardman homomorphism}]{\beta} & \text{KU}^4 & \xrightarrow[\text{Bott per.}]{=} & \text{KU} \\
 & & \xrightarrow{\text{C-field flux}} & & \xrightarrow{\text{RR-field flux}} & & \\
 & & G_4 & \xrightarrow{\text{}} & F_4 & & 
 \end{array}$$

J-twisted orbifold Cohomotopy  
around an orbi-singularity

$$\pi_G^4(\mathbb{R}_{\text{cpt}}^4)$$

un-stable/  
non-linear!

stabilization/  
linearization  $\Sigma^\infty$

equivariant  
stable Cohomotopy

$$\mathbb{S}_G^4(S^4)$$

Hurewicz-Boardman  
homomorphism  
(initiality of S)

$$\mathbb{S}_G^0$$

$\beta$

$$\xrightarrow[\text{[De06][Gui06]}]{\text{[BP72][Se74]}}$$

$$\mathbb{R}_{\mathbb{F}_1}(G)$$

$$\xrightarrow{\text{[Se71][tD79]}}$$

$$A_G$$

Burnside  
ring

equivariant  
orth. K-theory

$$\text{KO}_G^4(S^4)$$

$$\text{KO}_G^0$$

$$\xrightarrow{\otimes_{\mathbb{F}_1} \mathbb{R}} \mathbb{R}_{\mathbb{R}}(G)$$

further  
extension of scalars

$\otimes_{\mathbb{R}} \mathbb{C}$

$\otimes_{\mathbb{R}} \mathbb{C}$

equivariant  
complex K-theory

$$\text{KU}_G^4(S^4)$$

$$\text{KU}_G^0$$

$$\xrightarrow{\otimes_{\mathbb{R}} \mathbb{C}} \mathbb{R}_{\mathbb{C}}(G)$$

equivariant generalized  
cohomologies in RO-degree 4

equivariant generalized  
cohomologies of the point

representation  
rings

linearize virtual G-sets of fractional M-branes  
to virtual G-representations of fractional D-branes

Rem. [FSS20-Char, (353)].

The Boardman homomorphism exhibits exactly the identification  $G_4 \mapsto F_4$  of [DMW00]:

$$\begin{array}{ccccccc} \text{ch} \left\{ \begin{array}{l} \xrightarrow{\pi^4} \\ \xrightarrow{(G_4, G_7)} \end{array} \right. & \xrightarrow[\text{stabilization / linearization}]{\Sigma^\infty} & \mathbb{S}^4 & \xrightarrow[\text{Boardman homomorphism}]{\beta} & \text{KU}^4 & \xrightarrow[\text{Bott per.}]{=} & \text{KU} \\ & \mapsto & G_4 & \mapsto & F_4 & & \\ & & \text{C-field flux} & & \text{RR-field flux} & & \end{array}$$

However,  $\beta$  (and [DMW00]) misses the double dimensional reductions  $G_4 \mapsto H_3$  and  $G_7 \mapsto F_6$ ; these do appear from Cohomotopy via *cyclification* ([FSS16-RatCoh][FSS16-TDual][BSS19-RatSt]).

# Example: M5-tadpole cancellation.

[SS19-TadCnc]

$$\pi^{\int \gamma(\text{Fr})} \left( \mathbb{R}^{5,1|8} \times \gamma(\mathbb{T}^4 // \mathbb{Z}_2^A) \right) \simeq \pi_{\mathbb{Z}_2^A}^4(\mathbb{T}^4) \simeq \left\{ N_{M5} \cdot \mathbf{2} - N_{MO5} \cdot \mathbf{1} \mid \begin{array}{l} N_{MO5} \in \{0, \dots, 16\} \\ N_{M5} \in \mathbb{Z} \end{array} \right\} \leftarrow \text{non-additive!}$$

heterotic M5-charges according to Hypothesis H

equivariant 4-Cohomotopy

coincides with informal folklore

[SS19-TadCnc, Cor. 4.6]

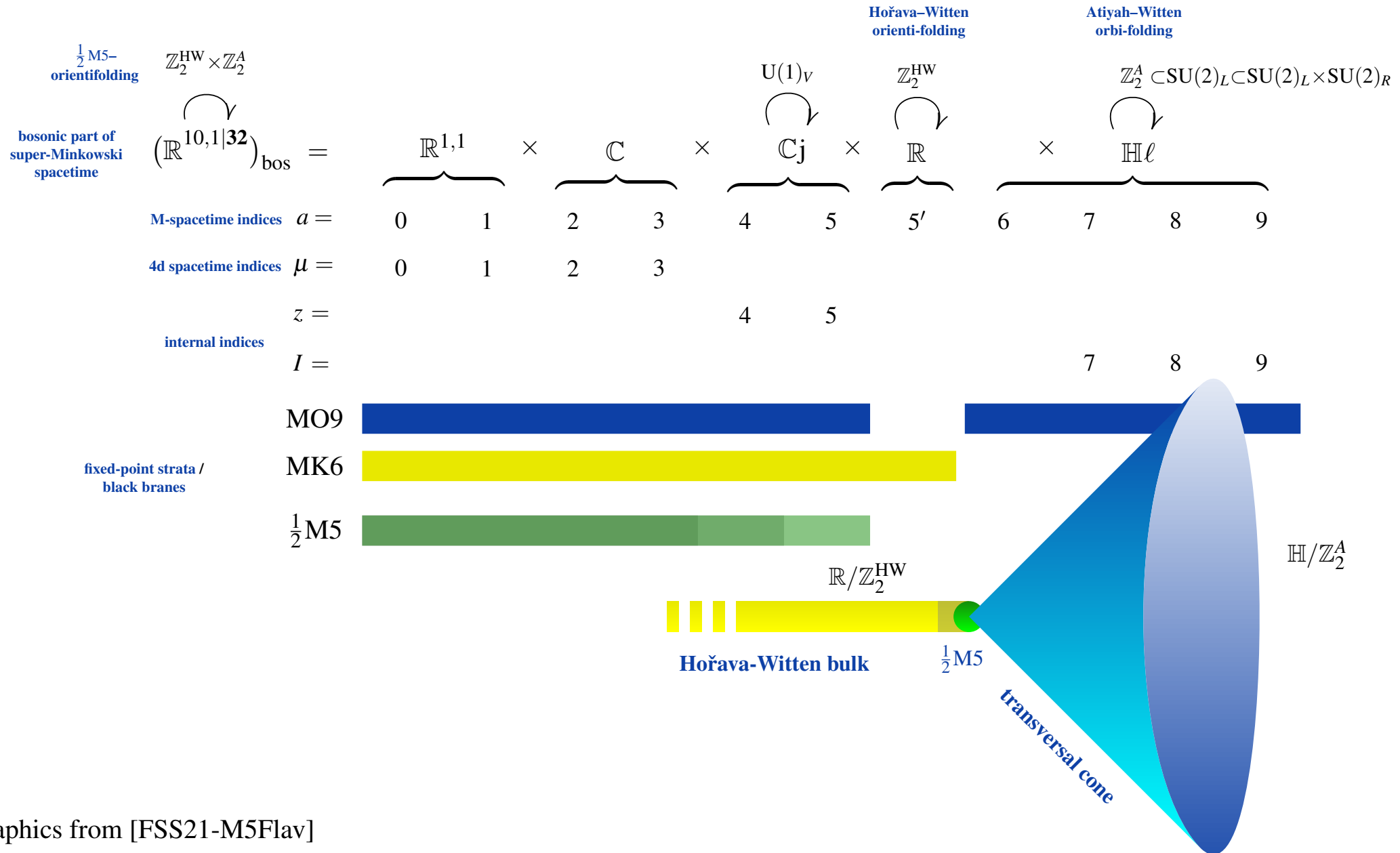

## Example: M5-tadpole cancellation.

[SS19-TadCnc]

$$\pi^{\int \gamma(\Gamma \text{ Fr})} \left( \mathbb{R}^{5,1|\mathbf{8}} \times \gamma(\mathbb{T}^4 // \mathbb{Z}_2^A) \right) \simeq \pi_{\mathbb{Z}_2^A}^4(\mathbb{T}^4) \simeq \left\{ N_{M5} \cdot \mathbf{2} - N_{MO5} \cdot \mathbf{1} \mid \begin{array}{l} N_{MO5} \in \{0, \dots, 16\} \\ N_{M5} \in \mathbb{Z} \end{array} \right\} \leftarrow \text{non-additive!}$$

heterotic M5-charges according to Hypothesis H      equivariant 4-Cohomotopy      coincides with informal folklore [SS19-TadCnc, Cor. 4.6]

---

We now explain this example in more detail.



# Background: The black M5 in 11d SuGra.

---

**Fact.** [AFFH99, 5.2] [dMFF12, §8.3]:

All BPS black M5-brane solutions of 11D supergravity are  $1/2$  BPS of this form:

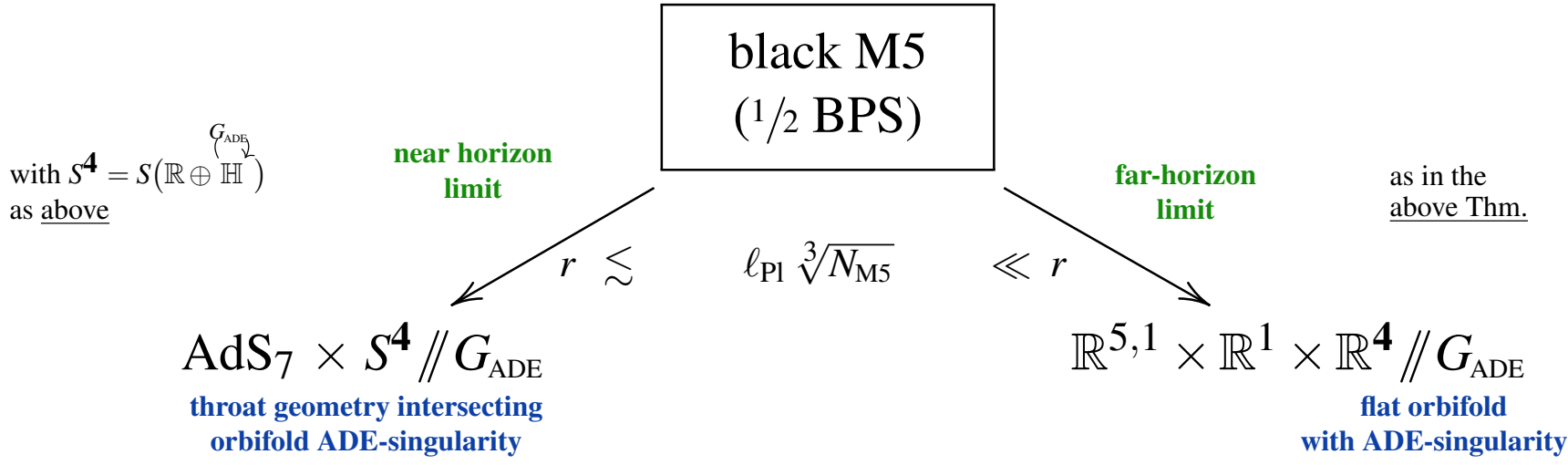

# Background: The black M5 in 11d SuGra.

**Fact.** [AFFH99, 5.2] [dMFF12, §8.3]:

All BPS black M5-brane solutions of 11D supergravity are  $1/2$  BPS of this form:

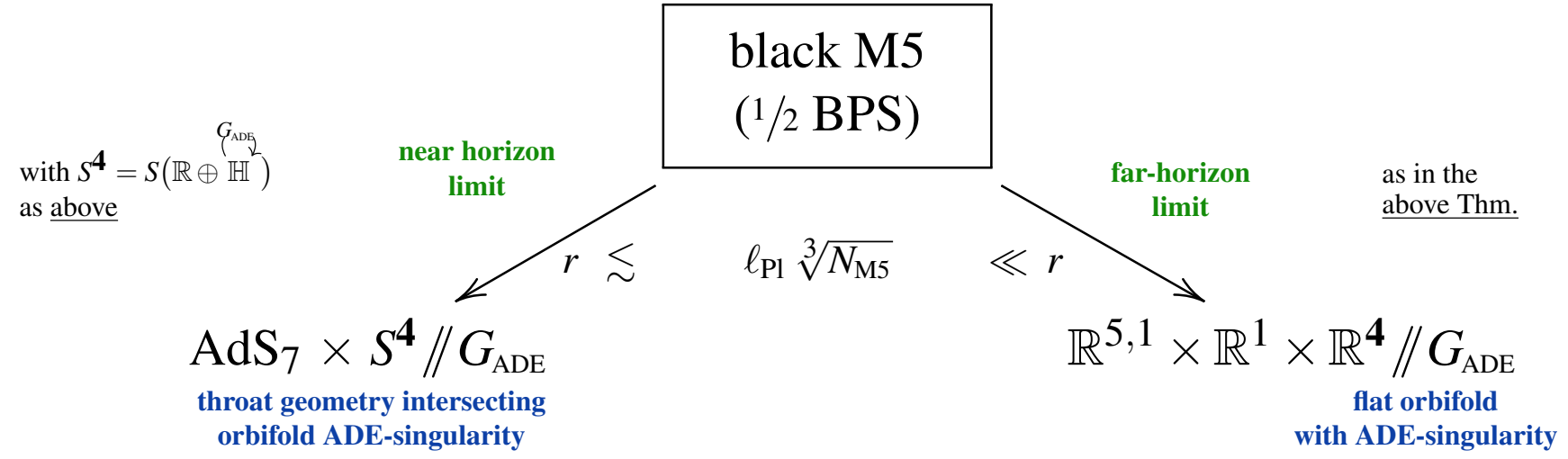

**Consequence 1:** Black BPS M5-branes are always domain walls inside an MK6-singularity:

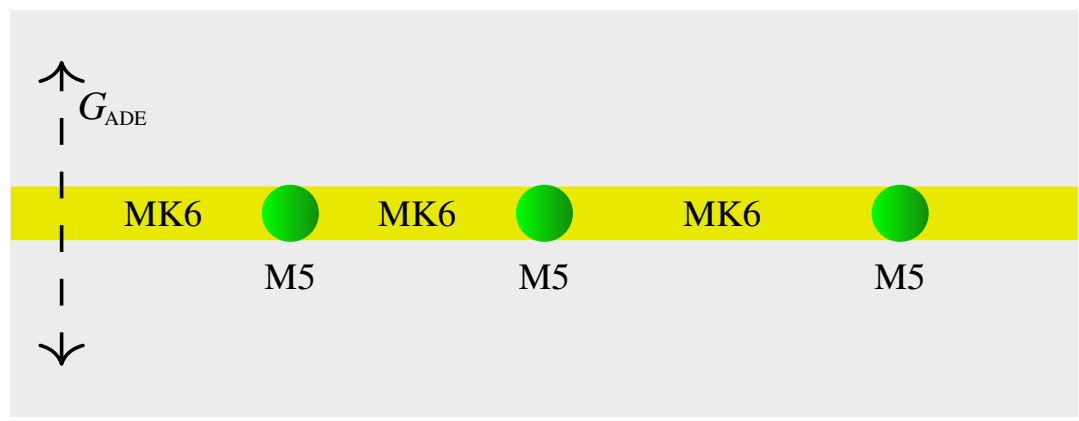

E.g.: [ZHTV14, §3.1] [Fa17, §3.3.1]



# Background: The black M5 in 11d SuGra.

**Fact.** [AFFH99, 5.2] [dMFF12, §8.3]:

All BPS black M5-brane solutions of 11D supergravity are  $1/2$  BPS of this form:

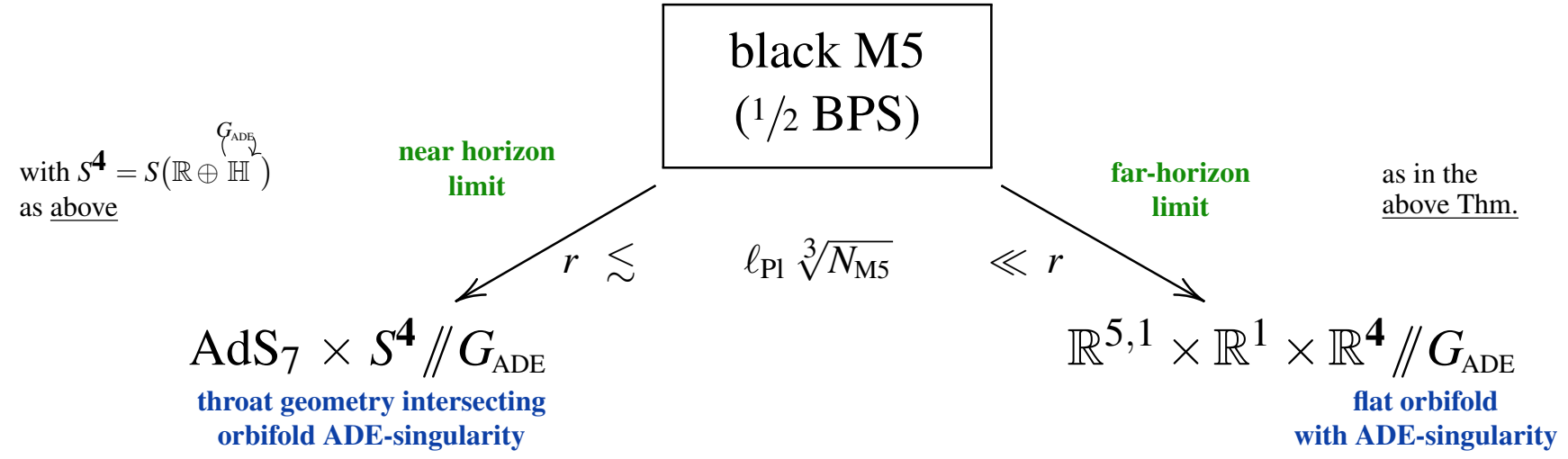

## Consequence 2:

Individual M5-branes  $N_{\text{M5}} \sim \mathcal{O}(1)^3$  have Planck scale thickness  $r \sim \ell_{\text{Pl}}$  hence their **near geometry make no sense** as solutions of M-theory due to infinite + unknown tower of higher curvature quantum corrections  $\sim (\ell_{\text{Pl}}^2 \cdot R)^k$ .

Planck area  
 Riem. curvature

Conversely:

The **M-meaningful far geometry** yields flat super-orbifold spacetimes where all curvature is crammed into orbi-singularities so that also all quantum effects must be hiding inside orbi-singularities – plausibly detected as charges measured in a proper orbifold cohomology theory!



# Quantum M-branes?

Hence, holding a quantum-microscope over a  $\frac{1}{2}$ M5 orbi-singularity, *should* show quantum M-branes of this form:

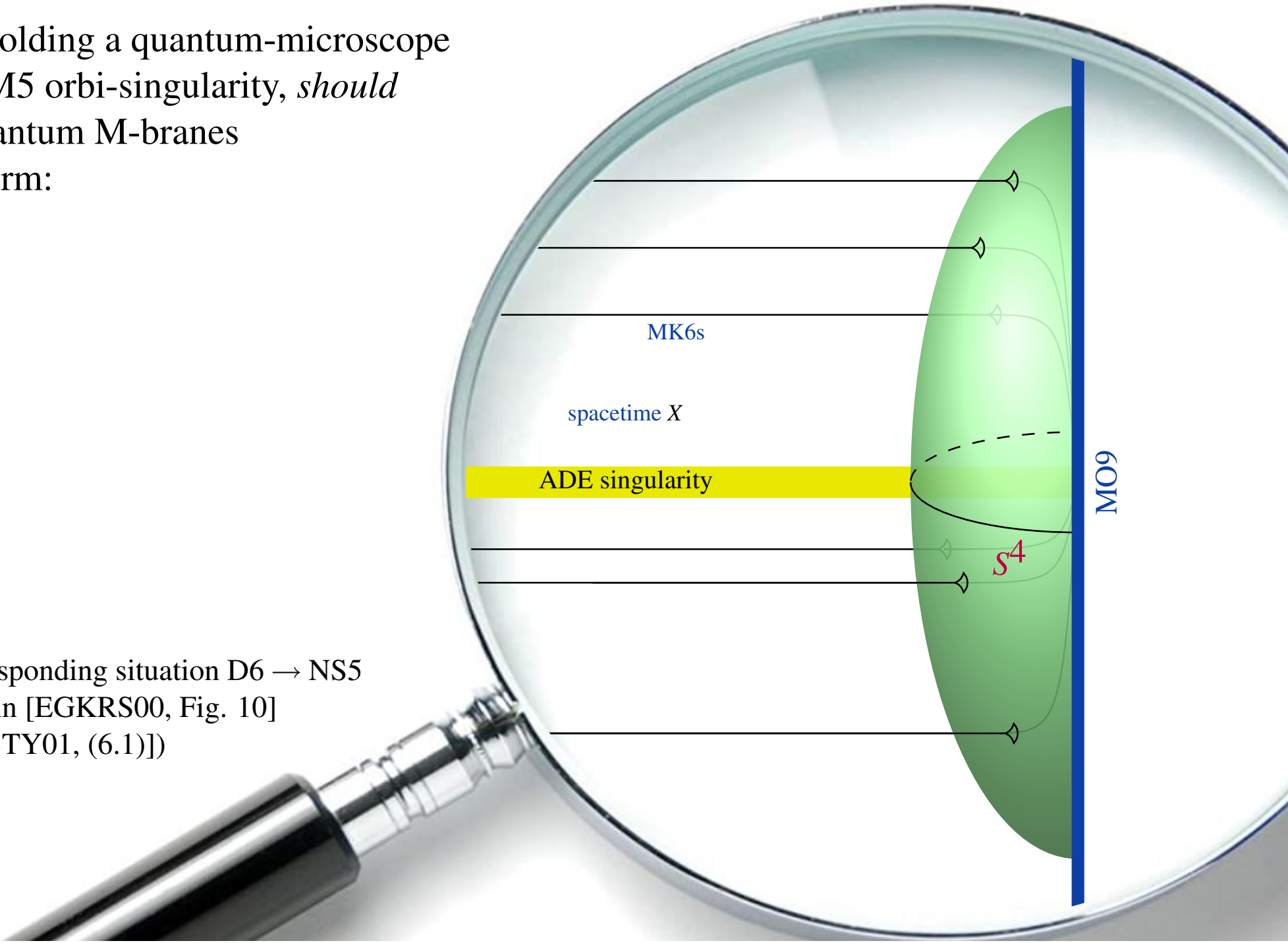

(the corresponding situation  $D6 \rightarrow NS5$  is shown in [EGKRS00, Fig. 10] and [GKSTY01, (6.1)])

Hence, holding a quantum-microscope over a  $\frac{1}{2}$ M5 orbi-singularity, *does* show quantum M-branes of this form:

Hypothesis H asserts that:  
*This quantum-microscope is J-twisted Cohomotopy theory.*

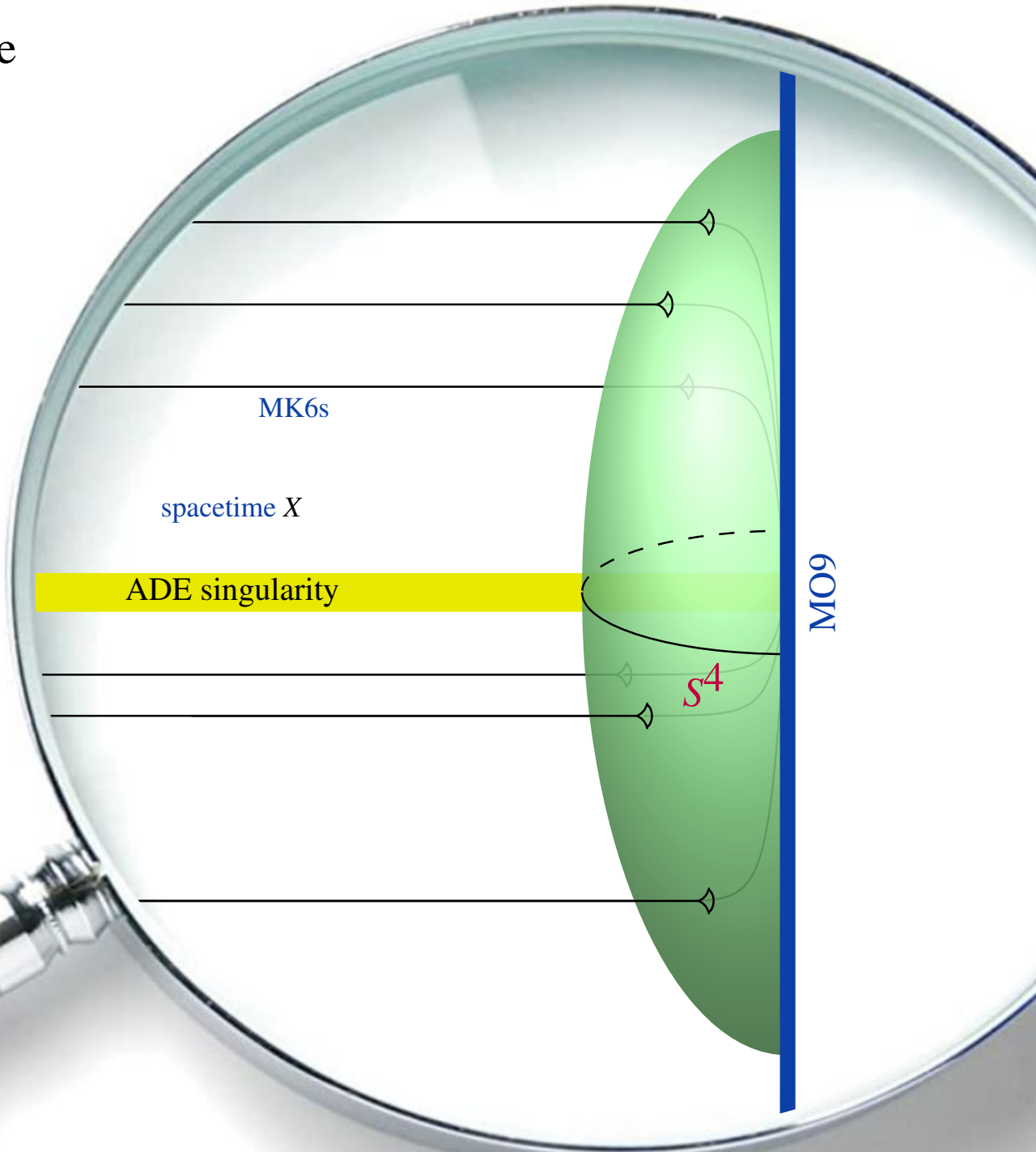

(the corresponding situation  $D6 \rightarrow NS5$  is shown in [EGKRS00, Fig. 10] and [GKSTY01, (6.1)])

# Cohomotopy charge map.

[SS19-TadCnc, §2.1] [SS21-MF, §2.2]

Namely, a small tubular neighbourhood of each MK6 carries  
*directed asymptotic transverse distance* from  $\frac{1}{2}$ M5 in MO9

$$\Rightarrow \text{Cohomotopy charge: } X \xrightarrow[\text{directed asymptotic transverse distance from MK6 loci in MO9-planes}]{\text{Cohomotopy charge}} (\mathbb{R}^4)^{\text{cpt}} = S^4$$

spacetime manifold
4-sphere
Cohomotopy coefficient

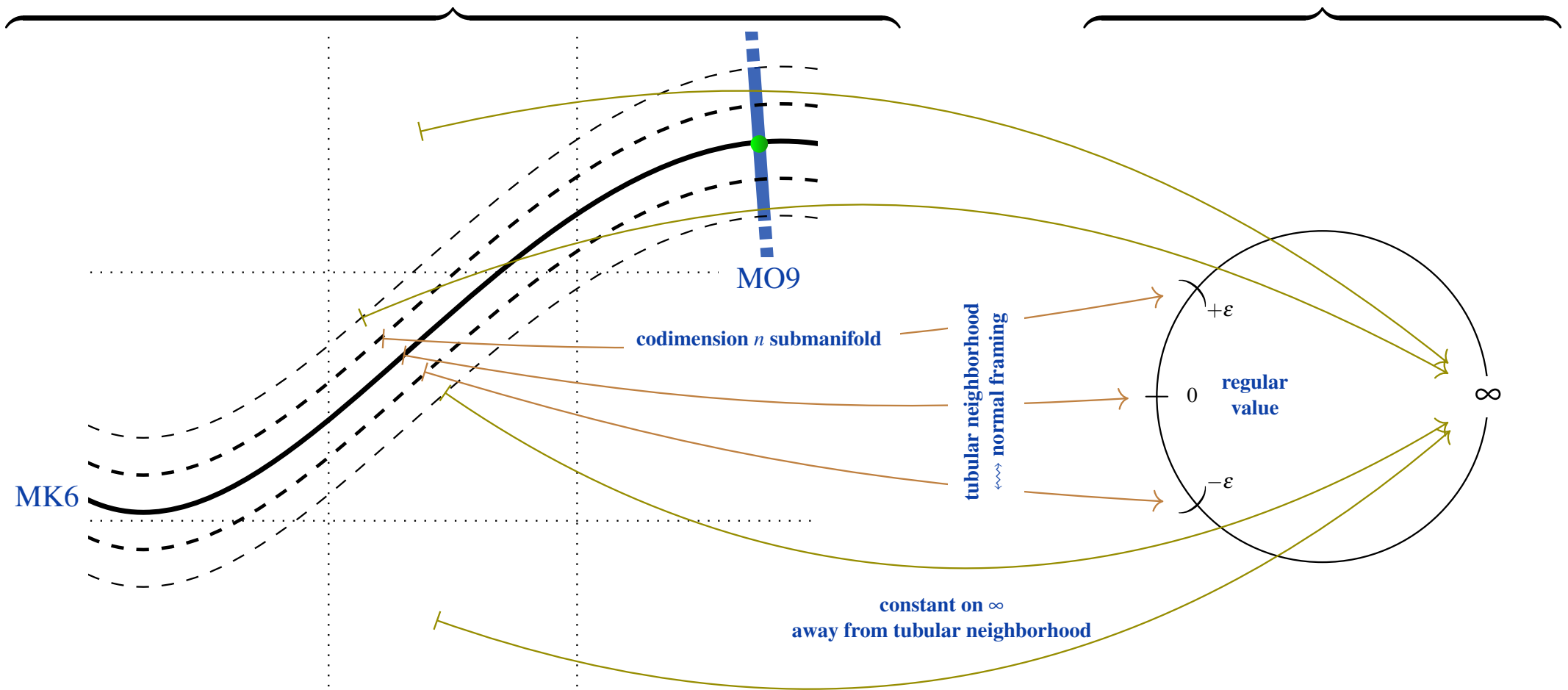

This construction and its reverse is Pontrjagin's construction ([Pon38], long before [Thom54]).

Under the above Pontrjagin construction one finds that:

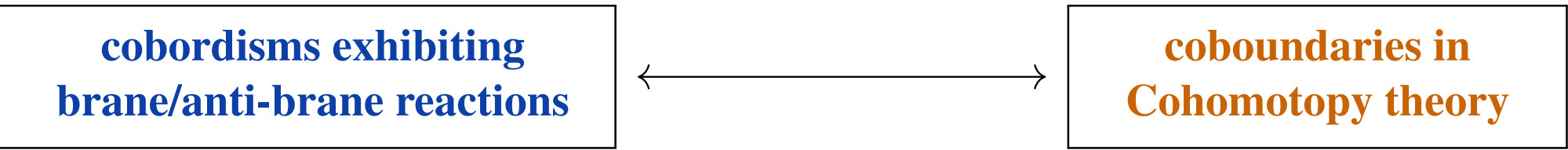

$$[0, 1] \times X \xrightarrow{0 \simeq (-1) + (+1)} (\mathbb{R}^n)^{\text{cpt}} = \mathcal{S}^n$$

product space of interval with manifold      coboundary in Cohomotopy       $n$ -sphere Cohomotopy coefficient

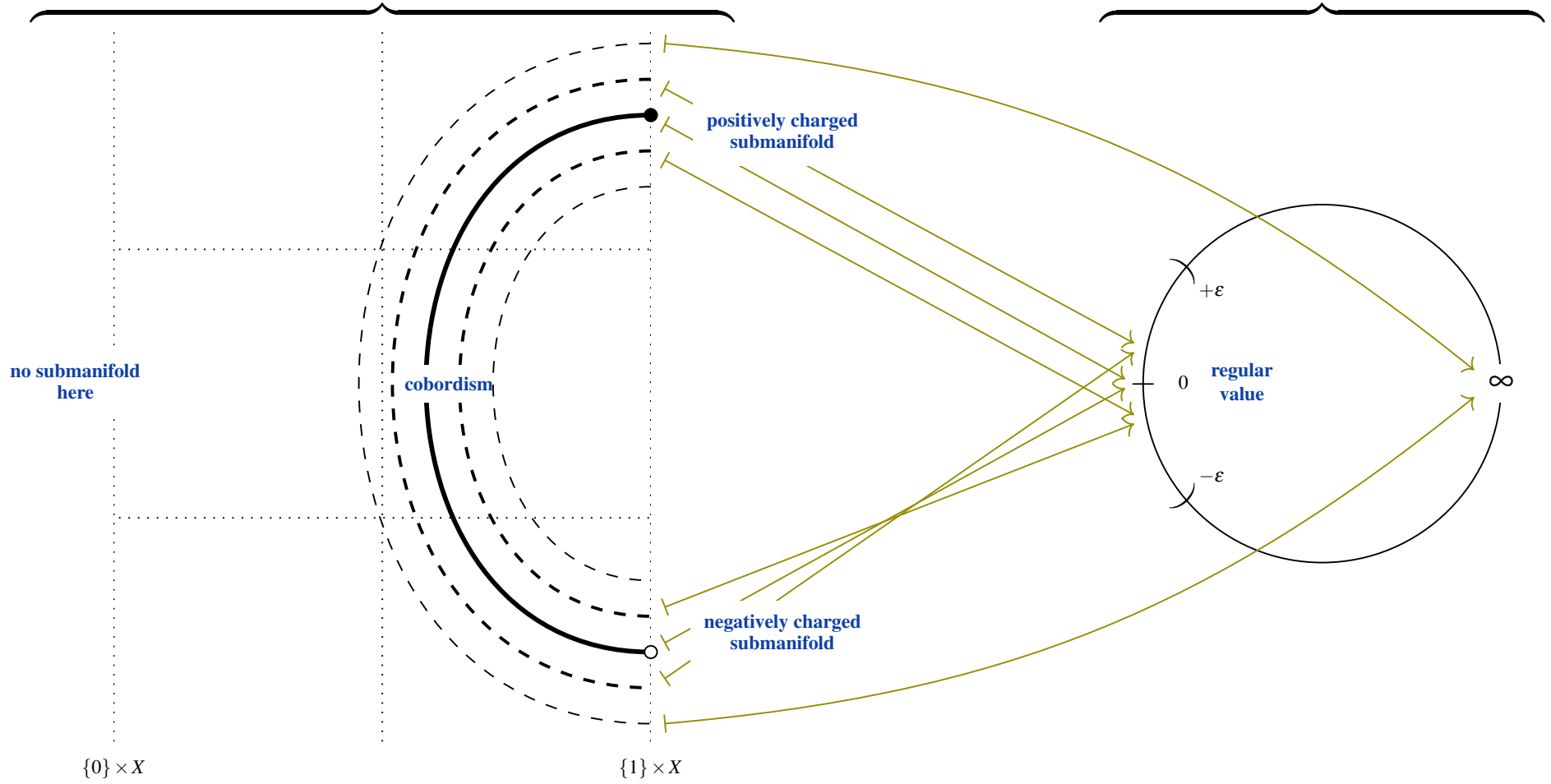

**Pontrjagin's theorem** says that

4-Cohomotopy is the conserved charge of these M-brane/anti-brane reactions in that the Cohomotopy charge map yields a *bijection* on cobordism classes:

Pontrjagin's theorem says that

4-Cohomotopy is the conserved charge of these M-brane/anti-brane reactions in that the Cohomotopy charge map yields a *bijection* on cobordism classes:

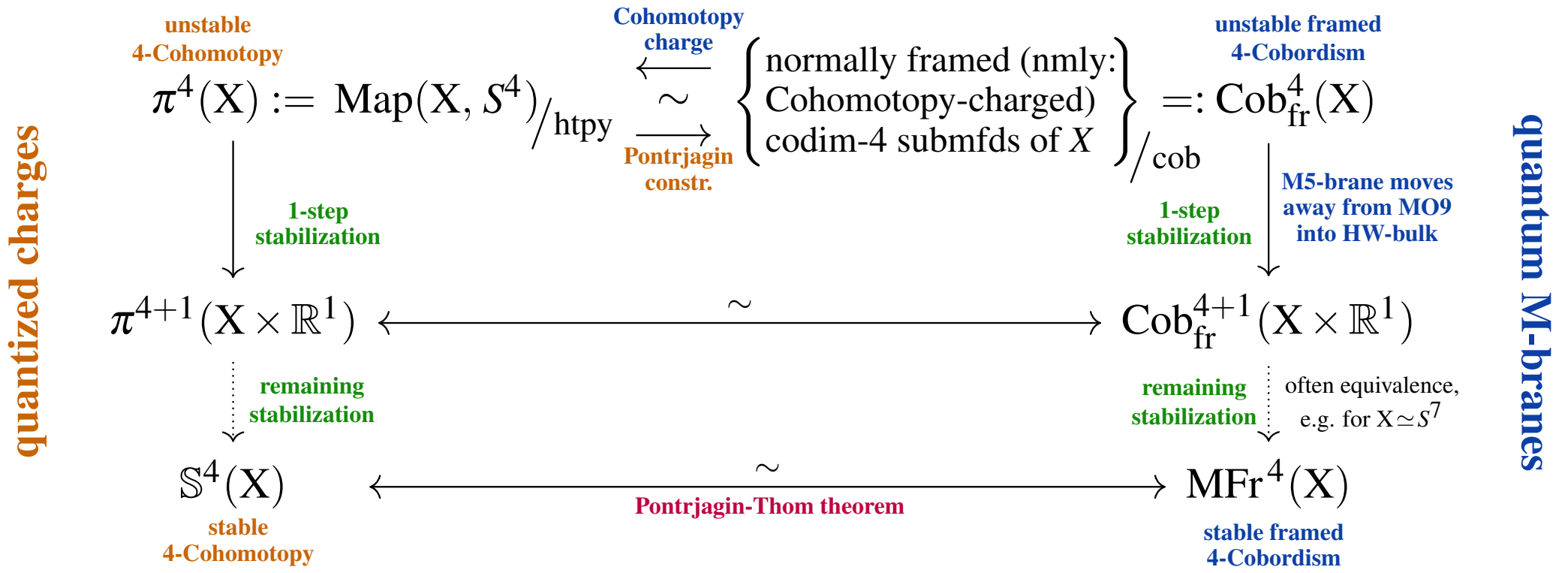



Pontrjagin's theorem says that

4-Cohomotopy is the conserved charge of these M-brane/anti-brane reactions in that the Cohomotopy charge map yields a *bijection* on cobordism classes:

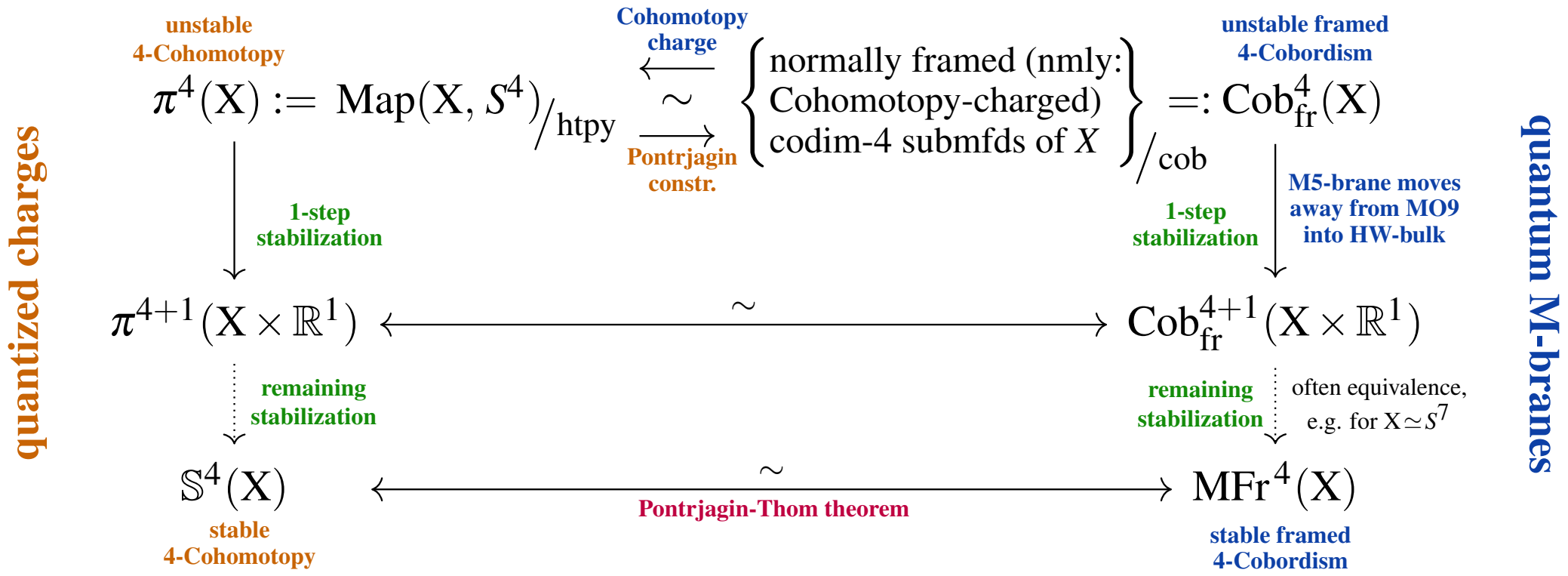

**Rem. 1.**

In particular this means that, in its stable = linearized approximation (cf above), Hypothesis H says equivalently that M-brane charge is quantized in stable framed Cobordism.

This is reminiscent of discussion in [McNamara & Vafa 19], see [SS21-MF, §4] for more.

Pontrjagin's theorem says that

4-Cohomotopy is the conserved charge of these M-brane/anti-brane reactions in that the Cohomotopy charge map yields a *bijection* on cobordism classes:

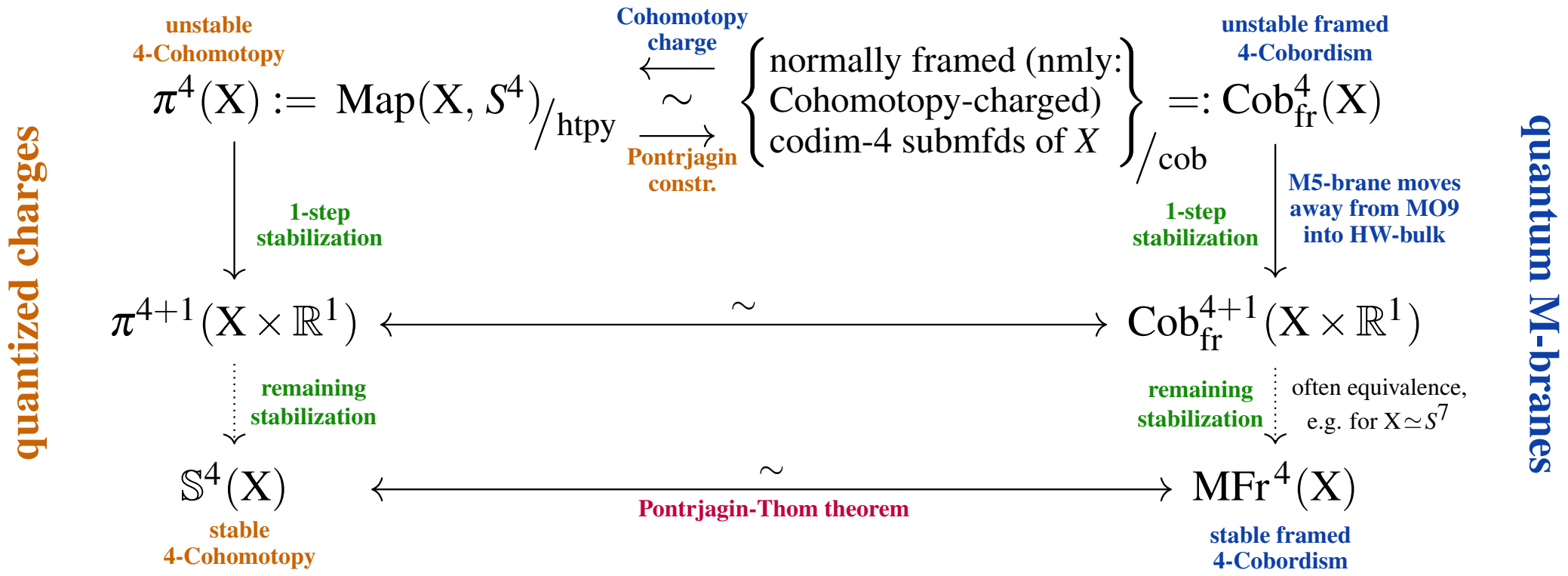

**Rem. 2.**

$$\text{equivariant Cohom. cocycles } \text{Map}(X, S^4)^{G_{\text{ADE}}} \xrightarrow{\text{forget equivariance}} \text{Map}(X, S^4) \text{ plain Cohom. cocycles}$$

Via the forgetful map

$$\pi_{G_{\text{ADE}}}^4(X) \xrightarrow{e^*} \pi^4(X)$$

the PT theorem allows to *see* the quantum M-branes around orb-singularities:



# Equivariant Cohomology of flat orbifolds.

Thm. 3.17 in [SS19-TadCnc]

**Thm.:** Charges in  $G_{ADE}$ -equivariant 4-Cohomology of  $\mathbb{T}^4$  are labeled by:

1. a choice of charge  $\in \{0, -1\}$  *inside* each singularity;
2. an integer number of  $|G_{ADE}|$ -tuples of mirror unit charges.

**Proof.:** Use tom Dieck's equivariant Hopf degree theorem.

[tD79, §8.4]

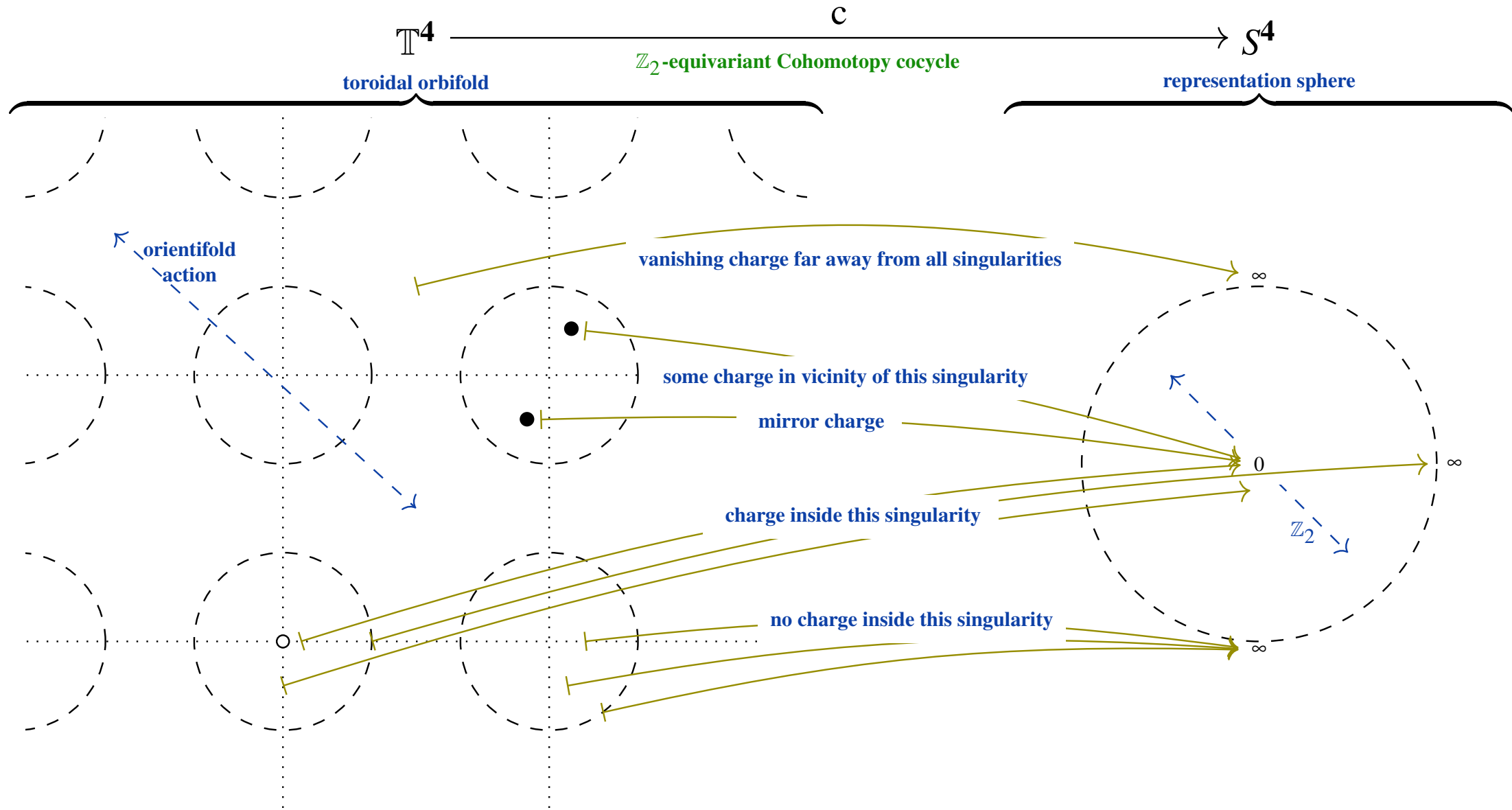

## **Tadpole cancellation in Cohomotopy.**

[SS19-TadCnc]

**Informal idea** of tadpole cancellation in string-theory and in M-theory:

- 1) total brane charge in compact transversal space must vanish; and yet there
  - 2) may/must be branes, countering opposite charges appearing inside O-plane singularities.
-

# Tadpole cancellation in Cohomotopy.

[SS19-TadCnc]

**Informal idea** of tadpole cancellation in string-theory and in M-theory:

- 1) total brane charge in compact transversal space must vanish; and yet there
- 2) may/must be branes, countering opposite charges appearing inside O-plane singularities.

**Formalization** in Cohomotopy theory according to Hypothesis H:

$$\begin{array}{ccc}
 \text{tadpole-free charges} & \pi_{G_{ADE}}^4(\mathbb{T}^4)_{\text{tot}=0} & \xrightarrow{\quad} \{0\} \\
 \text{fiber of tot-operation} & & \\
 & \downarrow & \downarrow \\
 \text{microscopic charges seen} & \pi_{G_{ADE}}^4(\mathbb{T}^4) & \xrightarrow[\text{sum up floating \& stuck charges inside orbifold}]{\text{tot}} \pi^4(\mathbb{T}^4) \\
 \text{in equivariant Cohomotopy} & & \text{non-abelian cohomology operation } (1 \longleftarrow G_{ADE})^* \\
 & \xrightarrow{2 \cdot 2 - 4 \cdot 1} & \xrightarrow{\quad} 0
 \end{array}$$

**Rem.** The condition  $\text{tot} = 0$  is naturally understood from *super-differential refinement* of Cohomotopy [SS19-TadCnc, (58)].

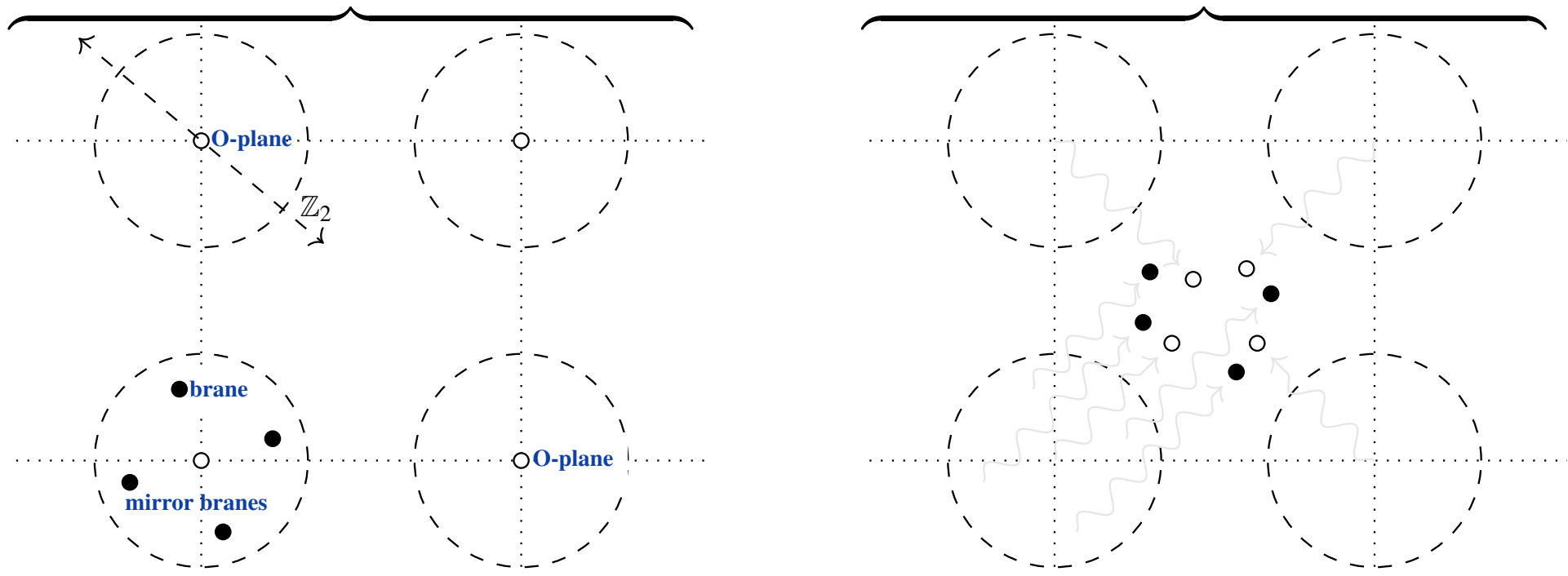

# Tadpole cancellation in Cohomotopy.

[SS19-TadCnc]

**Informal idea** of tadpole cancellation in string-theory and in M-theory:

- 1) total brane charge in compact transversal space must vanish; and yet there
- 2) may/must be branes, countering opposite charges appearing inside O-plane singularities.

**Formalization** in Cohomotopy theory according to Hypothesis H:

$$\begin{array}{ccc}
 \text{tadpole-free charges} & \pi_{G_{\text{ADE}}}^4(\mathbb{T}^4)_{\text{tot}=0} & \xrightarrow{\quad} \{0\} \\
 \text{fiber of tot-operation} & & \\
 & \downarrow & \downarrow \\
 \text{microscopic charges seen} & \pi_{G_{\text{ADE}}}^4(\mathbb{T}^4) & \xrightarrow{\text{tot}} \pi^4(\mathbb{T}^4) \\
 \text{in equivariant Cohomotopy} & \text{sum up floating \& stuck charges inside orbifold} & \text{total charge seen} \\
 & \text{non-abelian cohomology operation } (1 \mapsto G_{\text{ADE}})^* & \text{in plain Cohomotopy} \\
 & 2 \cdot 2 - 4 \cdot 1 \mapsto 0 & \\
 & \xrightarrow{\quad} & 
 \end{array}$$

**Rem.** The condition  $\text{tot} = 0$  is naturally understood from *super-differential refinement* of Cohomotopy [SS19-TadCnc, (58)].

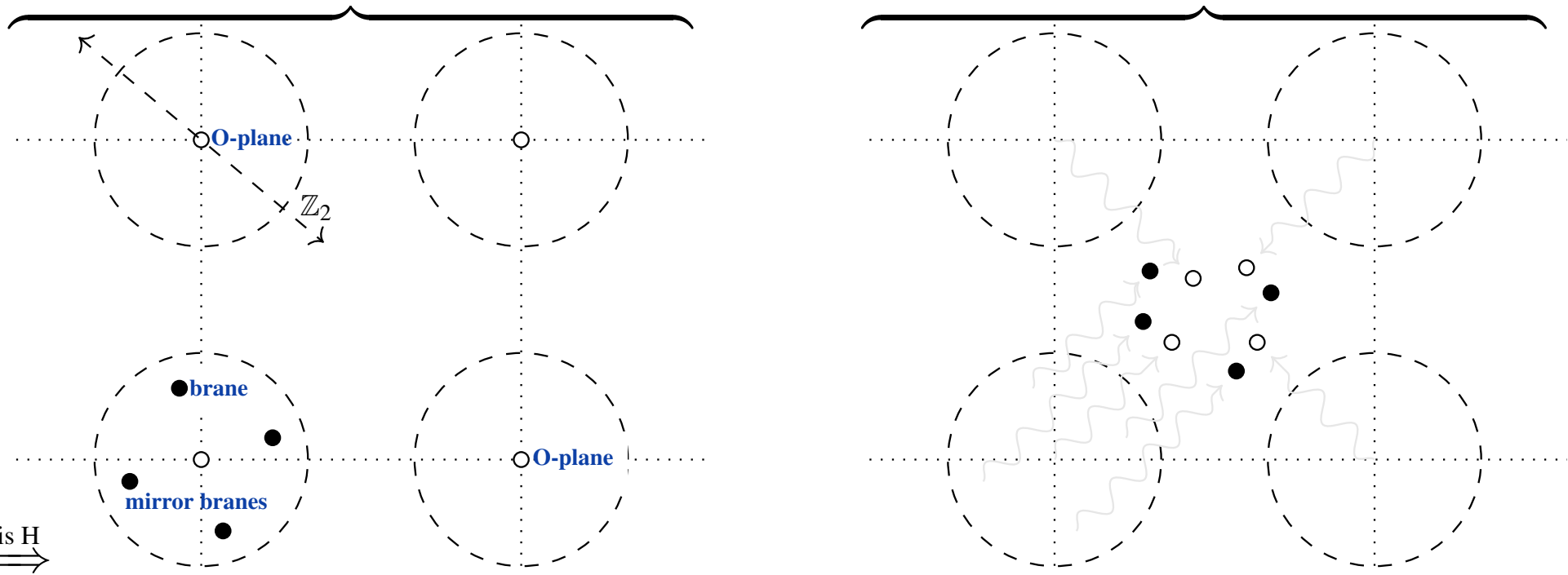

**MO5-planes carry  $-\frac{1}{2}$ M5-brane charge.** Proves old conjecture: [DM95, §2][Wi 95, §3][Ho98, §2.1].

## **Outlook – Further predictions.**

---

This concludes my survey of one prediction of Hypothesis H on flat orbifold spacetimes.

## **Outlook – Further predictions.**

---

This concludes my survey of one prediction of Hypothesis H on flat orbifold spacetimes.

Another prediction is the *absence of irrational* fractional D-brane charges [BSS19-FrcBrn], which solves a problem with (equivariant) K-theory highlighted in [BDS00][BDH<sup>+</sup>01,p. 89].



## Outlook – Further predictions.

---

This concludes my survey of one prediction of Hypothesis H on flat orbifold spacetimes.

Another prediction is the *absence of irrational* fractional D-brane charges [BSS19-FrcBrn], which solves a problem with (equivariant) K-theory highlighted in [BDS00][BDH<sup>+</sup>01,p. 89].

Among the predictions in the other limit, of smooth but curved spacetimes X, stands out the shifted 4-flux quantization [FSS19-HypH, Prop. 3.13][FSS20-Char, §5.3]:

$$\pi^\tau(\mathbf{X}) \xrightarrow{\text{ch}} \left\{ \begin{array}{l} G_7, \in \Omega^\bullet(\mathbf{X}) \left| \begin{array}{l} dG_7 = -\frac{1}{2}G_4 \wedge G_4 + \dots \\ dG_4 = 0, [G_4 + \frac{1}{4}p_1(\omega)] \in H^4(\mathbf{X}; \mathbb{Z}) \end{array} \right. \end{array} \right\} / \sim_{\text{conc}}$$

(where  $\tau$  is  $\text{Sp}(2) \times \text{Sp}(1)$ -structure on X and  $\omega$  is a compatible connection/field of gravity).

## Outlook – Further predictions.

---

This concludes my survey of one prediction of Hypothesis H on flat orbifold spacetimes.

Another prediction is the *absence of irrational* fractional D-brane charges [BSS19-FrcBrn], which solves a problem with (equivariant) K-theory highlighted in [BDS00][BDH<sup>+</sup>01,p. 89].

Among the predictions in the other limit, of smooth but curved spacetimes X, stands out the shifted 4-flux quantization [FSS19-HypH, Prop. 3.13][FSS20-Char, §5.3]:

$$\pi^\tau(\mathbf{X}) \xrightarrow{\text{ch}} \left\{ \begin{array}{l} G_7, \in \Omega^\bullet(\mathbf{X}) \\ G_4 \end{array} \left| \begin{array}{l} dG_7 = -\frac{1}{2}G_4 \wedge G_4 + \dots \\ dG_4 = 0, [G_4 + \frac{1}{4}p_1(\omega)] \in H^4(\mathbf{X}; \mathbb{Z}) \end{array} \right. \right\} / \sim_{\text{conc}}$$

(where  $\tau$  is  $\text{Sp}(2) \times \text{Sp}(1)$ -structure on X and  $\omega$  is a compatible connection/field of gravity).

That this shifted flux quantization should hold in M-theory is a famous proposal [Wi96a, 96b] & general. cohomology to capture this one condition has been purpose-built: [HS05][DFM07].

## Outlook – Further predictions.

---

This concludes my survey of one prediction of Hypothesis H on flat orbifold spacetimes.

Another prediction is the *absence of irrational* fractional D-brane charges [BSS19-FrcBrn], which solves a problem with (equivariant) K-theory highlighted in [BDS00][BDH<sup>+</sup>01,p. 89].

Among the predictions in the other limit, of smooth but curved spacetimes X, stands out the shifted 4-flux quantization [FSS19-HypH, Prop. 3.13][FSS20-Char, §5.3]:

$$\pi^\tau(\mathbf{X}) \xrightarrow{\text{ch}} \left\{ \begin{array}{l} G_7, \in \Omega^\bullet(\mathbf{X}) \\ G_4 \end{array} \left| \begin{array}{l} dG_7 = -\frac{1}{2}G_4 \wedge G_4 + \dots \\ dG_4 = 0, [G_4 + \frac{1}{4}p_1(\omega)] \in H^4(\mathbf{X}; \mathbb{Z}) \end{array} \right. \right\} / \sim_{\text{conc}}$$

(where  $\tau$  is  $\text{Sp}(2) \times \text{Sp}(1)$ -structure on X and  $\omega$  is a compatible connection/field of gravity).

That this shifted flux quantization should hold in M-theory is a famous proposal [Wi96a, 96b] & general. cohomology to capture this one condition has been purpose-built: [HS05][DFM07].

But various further consistency conditions on M-flux are expected, e.g.

Page charge quantization of  $G_7$ . Hypothesis H implies this, too: [FSS19-M5WZ, Thm. 4.8].

## **Outlook – Quantum M-Theory.**

---

Assuming Hypothesis H is  $\sim$  correct, a natural question arises:

## **Outlook – Quantum M-Theory.**

---

Assuming Hypothesis H is  $\sim$  correct, a natural question arises:

Beyond understanding the quantum moduli of the  $C$ -field,  
*do we get closer to a definition of full M-theory?*

## **Outlook – Quantum M-Theory.**

---

Assuming Hypothesis H is  $\sim$  correct, a natural question arises:

Beyond understanding the quantum moduli of the  $C$ -field,  
*do we get closer to a definition of full M-theory?*

On the above general grounds we expect with Hypothesis H, that quantum states of M-theory are positive elements in cohomology of the moduli  $\infty$ -stack of cocycles of J-twisted orbi-Cohomotopy:

# Outlook – Quantum M-Theory.

---

Assuming Hypothesis H is  $\sim$  correct, a natural question arises:

Beyond understanding the quantum moduli of the  $C$ -field,  
*do we get closer to a definition of full M-theory?*

On the above general grounds we expect with Hypothesis H, that quantum states of M-theory are positive elements in cohomology of the moduli  $\infty$ -stack of cocycles of J-twisted orbi-Cohomotopy:

$$\widehat{H}_{\text{pos}}^{\bullet} \left( \text{Map}^* \left( \mathcal{X}, \int \gamma \left( \widehat{S^4_{\text{Tate}}} // \text{Spin}(4) \right) \right)_{\int \gamma \mathbf{BSpin}(4)} \right)$$

*ab. cohomology*      *quantum states*  
*mapping stack*      *phase space of field histories*  
*cocycles of J-twisted*  
*diff. orbi-Cohomotopy*

## Outlook – Quantum M-Theory.

---

Assuming Hypothesis H is  $\sim$  correct, a natural question arises:

Beyond understanding the quantum moduli of the  $C$ -field,  
*do we get closer to a definition of full M-theory?*

On the above general grounds we expect with Hypothesis H, that quantum states of M-theory are positive elements in cohomology of the moduli  $\infty$ -stack of cocycles of J-twisted orbi-Cohomotopy:

$$\widehat{H}_{\text{pos}}^{\bullet} \left( \text{Map}^* \left( \mathcal{X}, \int \gamma \left( \widehat{S^4_{\text{Tate}}} // \text{Spin}(4) \right) \right)_{\int \gamma \mathbf{BSpin}(4)} \right)$$

*ab. cohomology*      *quantum states*  
*mapping stack*      *phase space of field histories*  
*cocycles of J-twisted*  
*diff. orbi-Cohomotopy*

We identified [CSS21-Quant, Thm. 1.2 & §4] such states in top. sector of  $D6 \perp D8$ -branes and discovered [SS19-Quant] structures expected from DBI- and Hanany-Witten arguments.



## Outlook – Quantum M-Theory.

---

Assuming Hypothesis H is  $\sim$  correct, a natural question arises:

Beyond understanding the quantum moduli of the  $C$ -field,  
*do we get closer to a definition of full M-theory?*

On the above general grounds we expect with Hypothesis H, that quantum states of M-theory are positive elements in cohomology of the moduli  $\infty$ -stack of cocycles of J-twisted orbi-Cohomotopy:

$$\widehat{H}_{\text{pos}}^{\bullet} \left( \text{Map}^* \left( \mathcal{X}, \int \gamma \left( \widehat{S^4_{\text{Tate}}} // \text{Spin}(4) \right) \right)_{\int \gamma \mathbf{BSpin}(4)} \right)$$

*ab. cohomology*      *quantum states*  
*mapping stack*      *phase space of field histories*  
*cocycles of J-twisted*  
*diff. orbi-Cohomotopy*

We identified [CSS21-Quant, Thm. 1.2 & §4] such states in top. sector of  $D6 \perp D8$ -branes and discovered [SS19-Quant] structures expected from DBI- and Hanany-Witten arguments.

So it looks promising...

these slides and further pointers are available at:

[ncatlab.org/schreiber/show/Proper+Orbifold+Cohomotopy+for+M-Theory](http://ncatlab.org/schreiber/show/Proper+Orbifold+Cohomotopy+for+M-Theory)

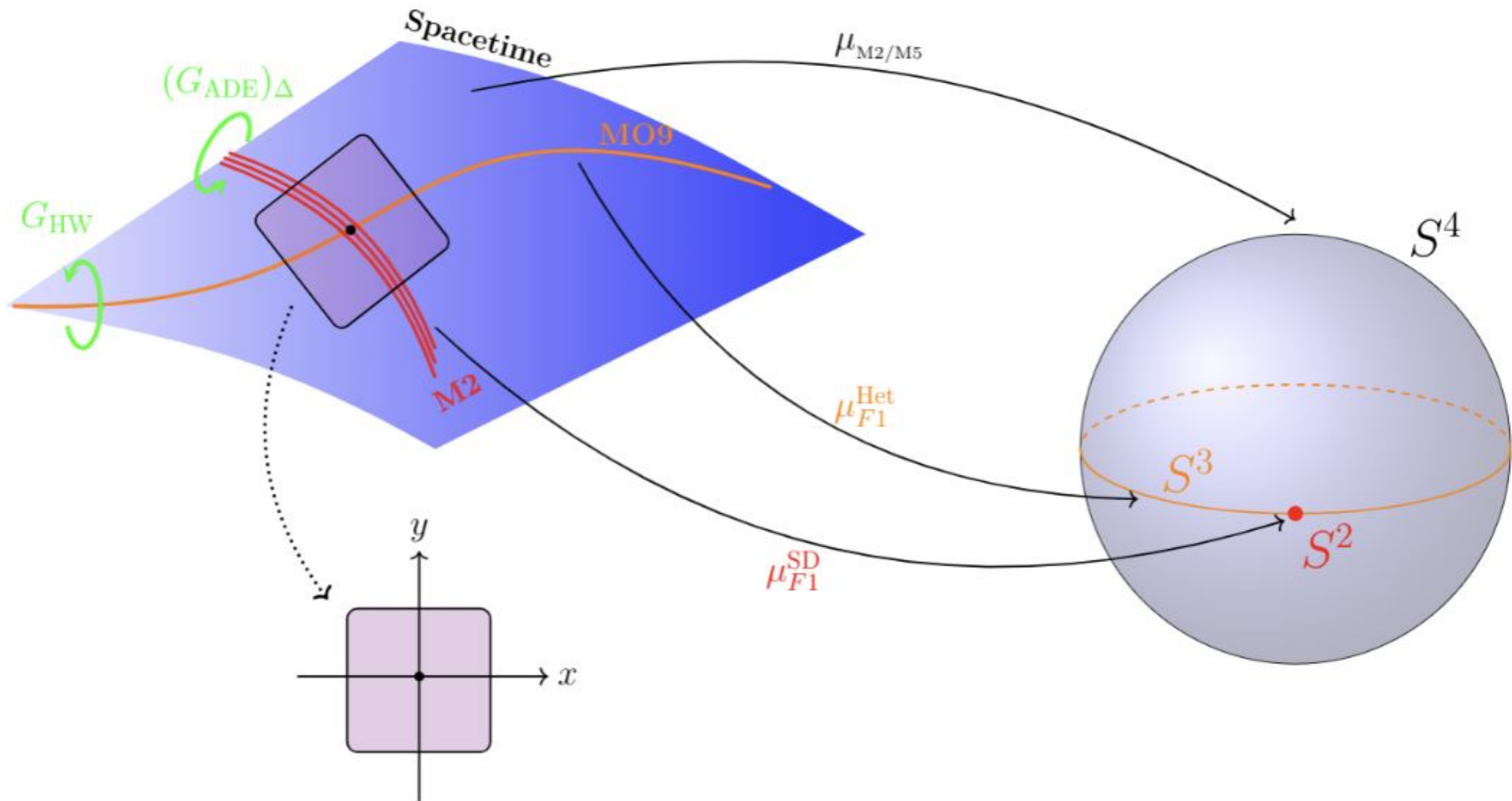

# References

[Sa13] H. Sati:

*Framed M-branes, corners, and topological invariants*

J Math Phys **59** (2018) 062304

[arXiv:1310.1060]

[FSS13-Bouq] D. Fiorenza, H. Sati, and U. Schreiber:

*Super Lie  $n$ -algebra extensions and higher WZW models*

Intern J Geom Meth Mod Phys **12** (2015) 1550018

[arXiv:1308.5264].

[FSS16-RatCoh] D. Fiorenza, H. Sati, and U. Schreiber:

*Rational sphere valued supercocycles in M-theory and type IIA string theory*

J Geom Phys **114** (2017) 91-108

[arXiv:1606.03206].

[BSS19-RatSt] V. Braunack-M, H. Sati, U. Schreiber:

*Gauge enhancement of M-Branes via rational param. stable homotopy theory*

Comm Math Phys **371** 197 (2019)

[arXiv:1806.01115]

[FSS19-RatM] D. Fiorenza, H. Sati and U. Schreiber:

*The rational higher structure of M-theory*

Fortsch Phys **67** 8-9 (2019)

[arXiv:1903.02834]

[FSS20-Char] D. Fiorenza, H. Sati, and U. Schreiber:

*The character map in (twisted differential) non-abelian cohomology*

[arXiv:2009.11909].

[SS21-MF] H. Sati and U. Schreiber: *M/F-Theory as  $Mf$ -Theory*

[arXiv:2103.01877]

# References

- [HSS18-ADE] J. Huerta, H. Sati and U. Schreiber:  
*Real ADE-equivariant (co)homotopy of super M-branes*,  
Comm Math Phys **371** (2019) 425  
[arXiv:1805.05987]
- [SS19-TadCnc] H. Sati and U. Schreiber:  
*Equivariant Cohomotopy implies orientifold tadpole cancellation*  
J Geom Phys **156** (2020) 103775  
[arXiv:1909.12277].
- [BSS19-FrcBrn] S. Burton, H. Sati and U. Schreiber:  
*Lift of fractional D-brane charge to equivariant Cohomotopy theory*  
J Geom Phys **161** (2021) 104034  
[arXiv:1812.09679]
- [SS20-M5GS] H. Sati and U. Schreiber:  
*The character map in equivariant twistorial Cohomotopy  
implies the Green-Schwarz mechanism with heterotic M5-branes*  
[arXiv:2011.06533]
- [SS20-OrbCoh] H. Sati and U. Schreiber:  
*Proper Orbifold Cohomology*  
[arXiv:2008.01101].
- [SS22-EquBun] H. Sati and U. Schreiber:  
*Equivariant principal  $\infty$ -bundles*  
(in preparation)

# References

- [FSS19-HypH] D. Fiorenza, H. Sati, and U. Schreiber:  
*Twisted Cohomotopy implies M-theory anomaly cancellation on 8-manifolds*  
Comm Math Phys **377** (2020), 1961–2025  
[arXiv:1904.10207].
- [FSS19-M5WZ] D. Fiorenza, H. Sati, and U. Schreiber:  
*Twisted Cohomotopy implies M5 WZ term level quantization*  
Comm Math Phys **384** (2021) 403–432  
[arXiv:1906.07417]
- [FSS20-M5Str] D. Fiorenza, H. Sati and U. Schreiber:  
*Twisted cohomotopy implies twisted String structure on M5-branes*  
J Math Phys **62** 042301 (2021)  
[doi:10.1063/5.0037786]
- [SS20-M5Anom] H. Sati and U. Schreiber:  
*Twisted Cohomotopy implies M5-brane anomaly cancellation*  
Lett Math Phys **111** (2021) 120  
[arXiv:2002.07737]
- [FSS20-GSAnom] D. Fiorenza, H. Sati, and U. Schreiber:  
*Twistorial Cohomotopy Implies Green-Schwarz anomaly cancellation*  
[arXiv:2008.08544]

# References

- [SSS09] H. Sati, U. Schreiber, and J. Stasheff:  
*Twisted differential string and fivebrane structures*  
Commun Math Phys **315** (2012) 169-213  
[arXiv:0910.4001]
- [FSS12] D. Fiorenza, H. Sati and Urs Schreiber: *The moduli 3-stack of the C-field*  
Comm Math Phys **333** 1 (2015) 117-151  
[arXiv:1202.2455]
- [NSS12- $\infty$ Bund] T. Nikolaus, U. Schreiber, and D. Stevenson:  
*Principal  $\infty$ -bundles – General theory*  
J Homot Rel Struc **10** (2015) 749–801  
[arXiv:1207.0248].
- [Sc13] U. Schreiber:  
*Differential cohomology in a cohesive  $\infty$ -topos*  
[arXiv:1310.7930].
- [ScSh14] U. Schreiber and M. Shulman:  
*Quantum Gauge Field Theory in Cohesive Homotopy Type Theory*  
EPTCS **158** (2014) 109-126  
[arXiv:1408.0054]
- [JSSW18-HigStrc] B. Jurčo, C. Saemann, U. Schreiber and M. Wolf:  
*Higher Structures in M-Theory*  
Fortsch Phys **67** 8-9 (2018)  
[arXiv:1903.02807]

# References

[SS19-Quant] H. Sati and U. Schreiber:

*Differential Cohomotopy implies intersecting brane observables  
via configuration spaces and chord diagrams,*

[arXiv:1912.10425].

[CSS21-Quant] D. Corfield, H. Sati and U. Schreiber:

*Fundamental weight systems are quantum states*

[arXiv:2105.02871]

[Sc14-Quant] U. Schreiber:

*Quantization via Linear Homotopy Types*

[arXiv:1402.7041]

[Sc16-HigGeo] U. Schreiber:

*Higher Prequantum Geometry*

in: *New Spaces for Mathematics and Physics*

Camb Univ Press 2021, ISBN:9781108854429

[arXiv:1601.05956]

[FSS16-TDual] D. Fiorenza, H. Sati, and U. Schreiber:

*T-Duality from super Lie  $n$ -algebra cocycles for super  $p$ -branes*

Adv Theor Math Phys **22** (2018) 1209-1270

[arXiv:1611.06536]

[SS18-MTDua] H. Sati and U. Schreiber:

*Higher T-duality in M-theory via local supersymmetry*

Phys Lett **B 781** (2018) 694-698

[arXiv:1805.00233]